

Description

The AZBDC10A4IC interface card and PWM servo drive assembly is designed to drive brushless and brushed DC motors at a high switching frequency. The interface card features quick-disconnect connectors. A DIP Switch is available to switch between brushless and brushed motors. The AZBDC10A4IC is fully protected against over-voltage, under-voltage, over-current, over-heating, and short-circuits. A single digital output indicates operating status. The drive interfaces with digital controllers that have digital PWM output. The PWM IN duty cycle determines the output current and DIR input determines the direction of rotation. This servo drive requires only a single unregulated isolated DC power supply, and is fully RoHS (Reduction of Hazardous Substances) compliant. Easily accessible test points are available for I/O and Feedback monitoring.

See Part Numbering Information on last page of datasheet for additional ordering options. The AZ Series Hardware Installation Manual is available for download at www.a-m-c.com.

Power Range

Peak Current	10 A
Continuous Current	5 A
Supply Voltage	10 - 36 VDC

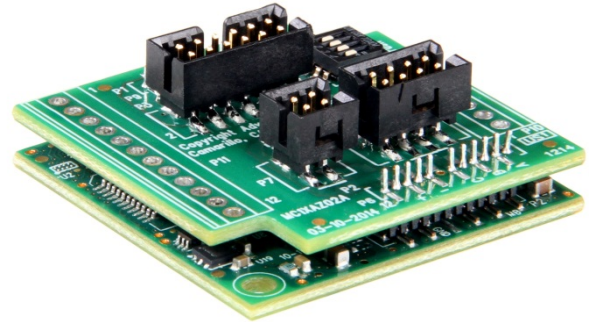

Features

- ▲ Detachable Connectors
- ▲ Four Quadrant Regenerative Operation
- ▲ Direct Board-to-Board Integration
- ▲ Lightweight
- ▲ High Switching Frequency
- ▲ Wide Temperature Range
- ▲ Differential Input Command
- ▲ Digital Fault Output Monitor
- ▲ Current Monitor Output
- ▲ Single Supply Operation
- ▲ Compact Size
- ▲ High Power Density
- ▲ 12VDC Operation

HARDWARE PROTECTION

- Over-Voltage
- Under-Voltage
- Over-Current
- Over-Temperature
- Short-circuit (phase-phase)
- Short-circuit (phase-ground)

INPUTS/OUTPUTS

- Digital Fault Output
- Digital Inhibit Input
- Analog Current Monitor
- Analog Command Input

FEEDBACK SUPPORTED

- Hall Sensors

MODES OF OPERATION

- Current

COMMUTATION

- Trapezoidal

MOTORS SUPPORTED

- Three Phase (Brushless)
- Single Phase (Brushed, Voice Coil, Inductive Load)

COMMAND SOURCE

- PWM

COMPLIANCES & AGENCY APPROVALS

- RoHS
- UL/cUL Pending
- CE Pending

BLOCK DIAGRAM

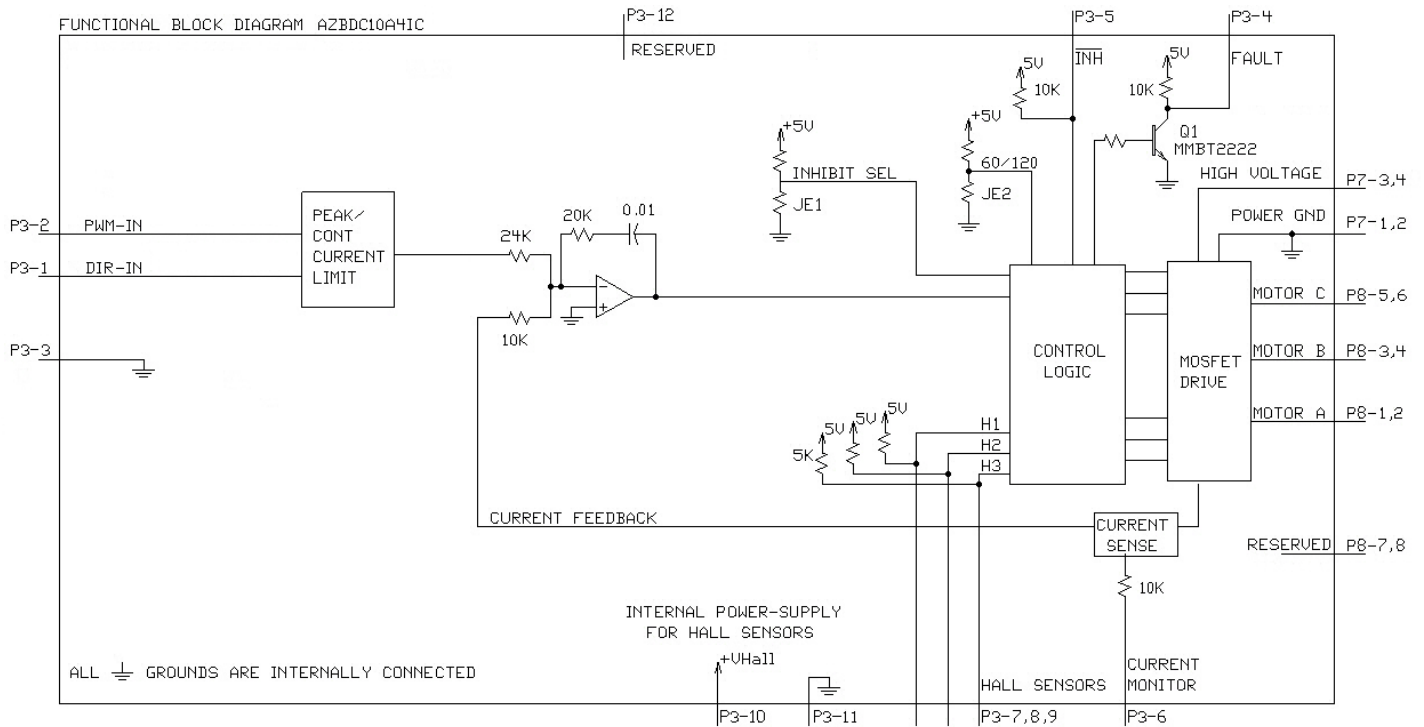

Information on Approvals and Compliances



RoHS (Reduction of Hazardous Substances) is intended to prevent hazardous substances such as lead from being manufactured in electrical and electronic equipment.

SPECIFICATIONS

Power Specifications		
Description	Units	Value
DC Supply Voltage Range	VDC	10 - 36
DC Bus Under Voltage Limit	VDC	8
DC Bus Over Voltage Limit	VDC	40
Maximum Peak Output Current ¹	A	10
Maximum Continuous Output Current	A	5
Maximum Continuous Output Power	W	171
Maximum Power Dissipation at Continuous Current	W	9
Minimum Load Inductance (Line-To-Line) ²	μH	100
Internal Bus Capacitance	μF	56.5
Low Voltage Supply Outputs	-	+5 VDC (30 mA)
Switching Frequency	kHz	40
Control Specifications		
Description	Units	Value
Command Sources	-	PWM
PWM Input Frequency Range	-	10 - 25
Feedback Supported	-	Halls
Commutation Methods	-	Trapezoidal
Modes of Operation	-	Current
Motors Supported	-	Three Phase (Brushless), Single Phase (Brushed, Voice Coil, Inductive Load)
Hardware Protection	-	Invalid Commutation Feedback, Over Current, Over Temperature, Over Voltage, Under Voltage, Short Circuit (Phase-Phase & Phase-Ground)
Mechanical Specifications		
Description	Units	Value
Agency Approvals	-	RoHS, UL/cUL Pending, CE Pending
Size (H x W x D)	mm (in)	38.1 x 38.1 x 16.6 (1.50 x 1.50 x 0.65)
Weight	g (oz)	17 (0.6)
Operating Temperature Range ³	°C (°F)	0 - 85 (32 - 185)
Storage Temperature Range	°C (°F)	-40 - 85 (-40 - 185)
Relative Humidity	-	0 - 90% Non-Condensing
Form Factor	-	PCB Mounted
P3 Connector	-	12-port, 2.0 mm spaced header, vertical mount
P7 Connector	-	4-port, 2.0 mm spaced header, vertical mount
P8 Connector	-	8-port, 2.0 mm spaced header, vertical mount

Notes

1. Maximum duration of peak current is ~2 seconds. Peak RMS value must not exceed continuous current rating of the drive.
2. Lower inductance is acceptable for bus voltages well below maximum. Use external inductance to meet requirements.
3. Additional cooling and/or heatsink may be required to achieve rated performance.

PIN FUNCTIONS

P3 - Signal Connector			
Pin	Name	Description / Notes	I/O
1	DIRECTION	Direction Input (+5V)	I
2	PWM / IN	10 – 25 kHz pulse width modulated digital input command (+5V). Input duty cycle commands the output current.	I
3	SIGNAL GND	Signal Ground (Common With Power Ground).	GND
4	FAULT OUT	TTL level (+5 V) output becomes high when power devices are disabled due to at least one of the following conditions: inhibit, invalid Hall state, output short circuit, over voltage, over temperature, power-up reset.	O
5	INHIBIT IN	TTL level (+5 V) inhibit/enable input. Leave open to enable drive. Pull to ground to inhibit drive. Inhibit turns off all power devices. For reverse inhibit logic, use –INV ordering option.	I
6	CURRENT MONITOR	Current Monitor. Analog output signal proportional to the actual current output. Scaling is 2 A/V. Measure relative to signal ground.	O
7	HALL 3	Single-ended Hall/Commutation Sensor Inputs (+5 V logic level)	I
8	HALL 2		I
9	HALL 1		I
10	+V HALL OUT	Low Power Supply For Hall Sensors (+5 V @ 30 mA). Referenced to signal ground. Short circuit protected.	O
11	SIGNAL GND	Signal Ground (Common With Power Ground).	GND
12	RESERVED	Reserved	-

P7 - Power Connector			
Pin	Name	Description / Notes	I/O
1	PWR GND	Power Ground (Common With Signal Ground). 3A Continuous Current Rating Per Pin	GND
2	PWR GND		GND
3	HV IN	DC Power Input. 3A Continuous Current Rating Per Pin. Requires a minimum of 47 μ F external capacitance between HV IN and PWR GND pins.	I
4	HV IN		I

P8 – Motor Power Connector			
Pin	Name	Description / Notes	I/O
1	MOTOR A	Motor Phase Outputs*. Current output distributed equally across 2 pins per motor phase, 3A continuous current carrying capacity per pin.	O
2	MOTOR A		O
3	MOTOR B		O
4	MOTOR B		O
5	MOTOR C		O
6	MOTOR C		O
7	RESERVED	Reserved	-
8	RESERVED		-

*For use with Single Phase (Brushed) motors, set Switch 1 to ON (see Hardware Settings below) and only connect motor leads to Motor A and Motor B.

HARDWARE SETTINGS

DIP Switch Settings

When set to the ON position, DIP Switch SW1 internally shorts Hall 2 to ground for use with single phase (brushed) motors. Note that in this configuration, all Hall signal pins should be left open, and only motor phase outputs A and B should be used. Default switch setting is OFF (three phase / brushless motors).

DIP Switches SW2, SW3, SW4 are reserved.

MECHANICAL INFORMATION

P3 – I/O Connector

Connector Information	12-port, 2.0 mm spaced header, vertical mount	
Mating Connector	Details	Molex: P/N 51110-1260 (housing) ; 50394-8051 (crimp pins)
	Included with Drive	Yes

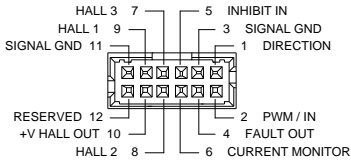

P7 – Power Connector

Connector Information	4-port, 2.0 mm spaced header, vertical mount	
Mating Connector	Details	Molex: P/N 51110-0460 (housing) ; 50394-8051 (crimp pins)
	Included with Drive	Yes

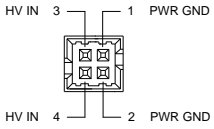

P8 – Motor Power Connector

Connector Information	8-port, 2.0 mm spaced header, vertical mount	
Mating Connector	Details	Molex: P/N 51110-0860 (housing) ; 50394-8051 (crimp pins)
	Included with Drive	Yes

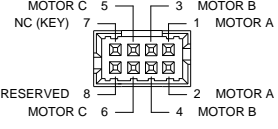

MOUNTING DIMENSIONS

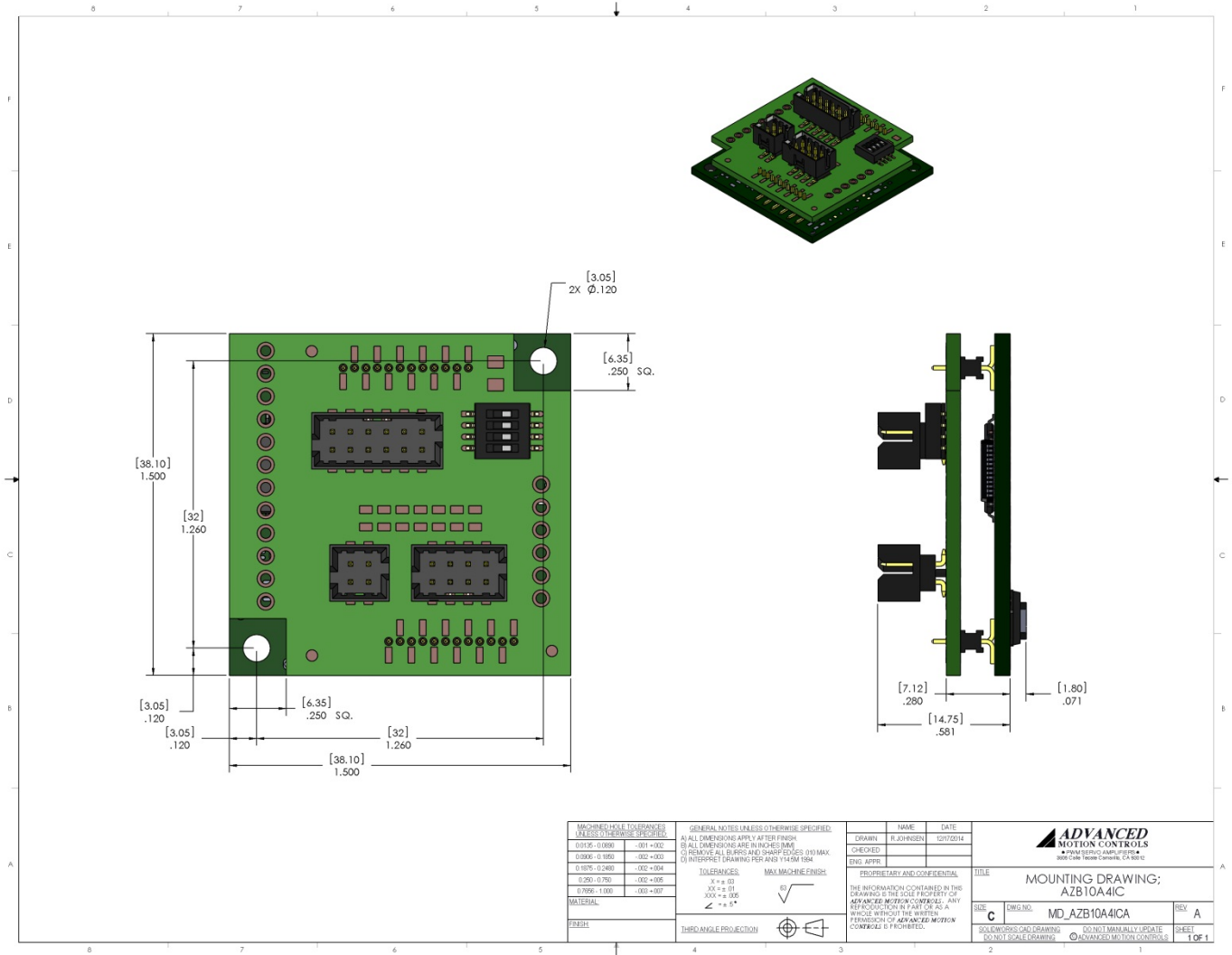

PART NUMBERING INFORMATION

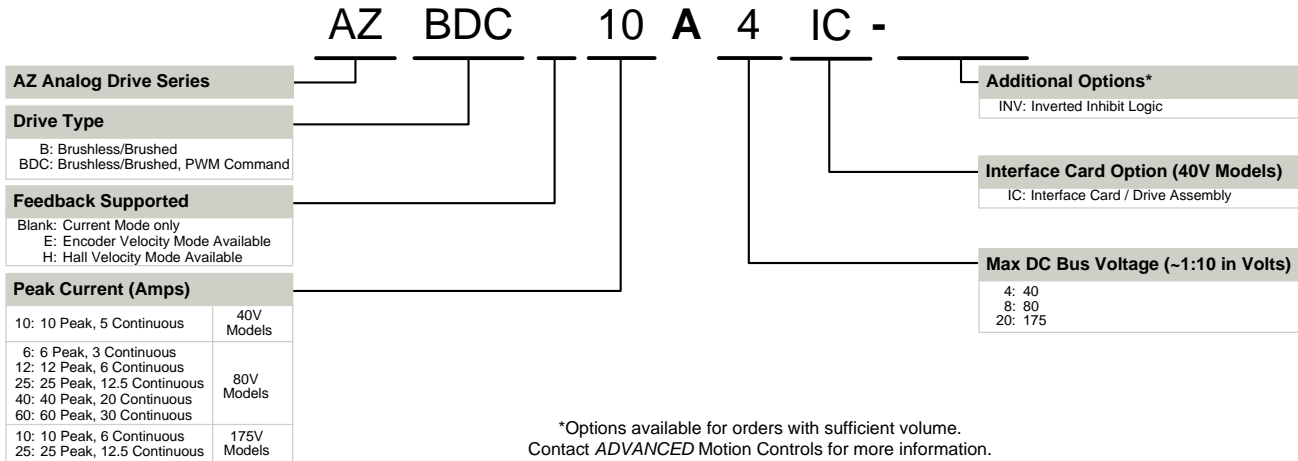

ADVANCED Motion Controls AZ series of servo drives are available in many configurations. Note that not all possible part number combinations are offered as standard drives. All models listed in the selection tables of the website are readily available, standard product offerings.

ADVANCED Motion Controls also has the capability to promptly develop and deliver specified products for OEMs with volume requests. Our Applications and Engineering Departments will work closely with your design team through all stages of development in order to provide the best servo drive solution for your system. Equipped with on-site manufacturing for quick-turn customs capabilities, ADVANCED Motion Controls utilizes our years of engineering and manufacturing expertise to decrease your costs and time-to-market while increasing system quality and reliability.

Examples of Modifications and Customized Products

- ▲ Integrate OEM Circuitry onto Drive PCB
- ▲ Custom Control Loop Tuned to Motor Characteristics
- ▲ Mount OEM PCB onto Drive Without Cables
- ▲ Custom I/O Interface for System Compatibility
- ▲ Multi-axis Configuration for Compact System
- ▲ Preset Switches and Pots to Reduce User Setup
- ▲ Custom PCB and Baseplate for Optimized Footprint
- ▲ Optimized Switching Frequency
- ▲ RTV/Epoxy Components for High Vibration
- ▲ Ramped Velocity Command for Smooth Acceleration
- ▲ OEM Specified Connectors for Instant Compatibility
- ▲ Remove Unused Features to Reduce OEM Cost
- ▲ OEM Specified Silkscreen for Custom Appearance
- ▲ Application Specific Current and Voltage Limits
- ▲ Increased Thermal Limits for High Temp. Operation

Feel free to contact Applications Engineering for further information and details.

Available Accessories

ADVANCED Motion Controls offers a variety of accessories designed to facilitate drive integration into a servo system. Visit www.a-m-c.com to see which accessories will assist with your application design and implementation.

