

FE060-5-CM

FlexPro® Series

Product Status: Active

SPECIFICATIONS

Current Peak	10 A
Current Continuous	5 A
DC Supply Voltage	10 – 55 VDC
Network Communication	CANopen

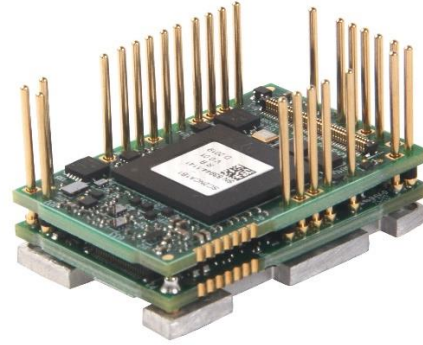

The **FE060-5-CM** is a FlexPro® series servo drive with IMPACT™ architecture.

The **FE060-5-CM** offers full tuning control of all servo loops and is designed to drive brushed and brushless servo motors, stepper motors, and AC induction motors. The drive accepts a variety of external command signals, or can use the built-in Motion Engine, an internal motion controller used with Sequencing and Indexing commands. Programmable digital and analog I/O are included to enhance interfacing with external controllers and devices.

The **FE060-5-CM** features a CANopen interface for network communication and USB connectivity for drive configuration and setup. All drive and motor parameters are stored in non-volatile memory.

IMPACT™ (Integrated Motion Platform And Control Technology) combines exceptional processing capability and high-current components to create powerful, compact, feature-loaded servo solutions. IMPACT™ is used in all FlexPro® drives and is available in custom products as well.

FEATURES

- Follows the CAN in Automation (CiA) 301 Communications Profile and 402 Device Profile
- Four Quadrant Regenerative Operation
- Programmable Gain Settings
- PIDF Velocity Loop
- Space Vector Modulation (SVM) Technology
- Fully Configurable Current, Voltage, Velocity and Position Limits
- Compact Size, High Power Density
- On-the-Fly Mode Switching
- On-the-Fly Gain Set Switching
- Dedicated Safe Torque Off (STO) Inputs

Feedback Supported	<ul style="list-style-type: none"> • Absolute Encoder <ul style="list-style-type: none"> ○ BiSS C-Mode ○ EnDat 2.2 • Incremental Encoder • Hall Sensors • Aux Incremental Encoder • ±10 VDC Position • Tachometer (±10V) 	Motors Supported	<ul style="list-style-type: none"> • Three Phase • Single Phase • Stepper • AC Induction 	Modes of Operation	<ul style="list-style-type: none"> • Profile Modes • Cyclic Synchronous Modes • Current • Velocity • Position • Interpolated Position Mode (PVT)
Command Sources	<ul style="list-style-type: none"> • Over the Network • ±10V Analog • Sequencing • Indexing • Jogging • Step & Direction • Encoder Following 	Inputs / Outputs	<ul style="list-style-type: none"> • 4 Programmable Digital Inputs • 3 Programmable Digital Outputs • 1 Programmable Analog Input 	Agency Approvals	<ul style="list-style-type: none"> • RoHS • UL (Pending) • CE (Pending) • TUV Rheinland (STO) (Pending)

BLOCK DIAGRAM

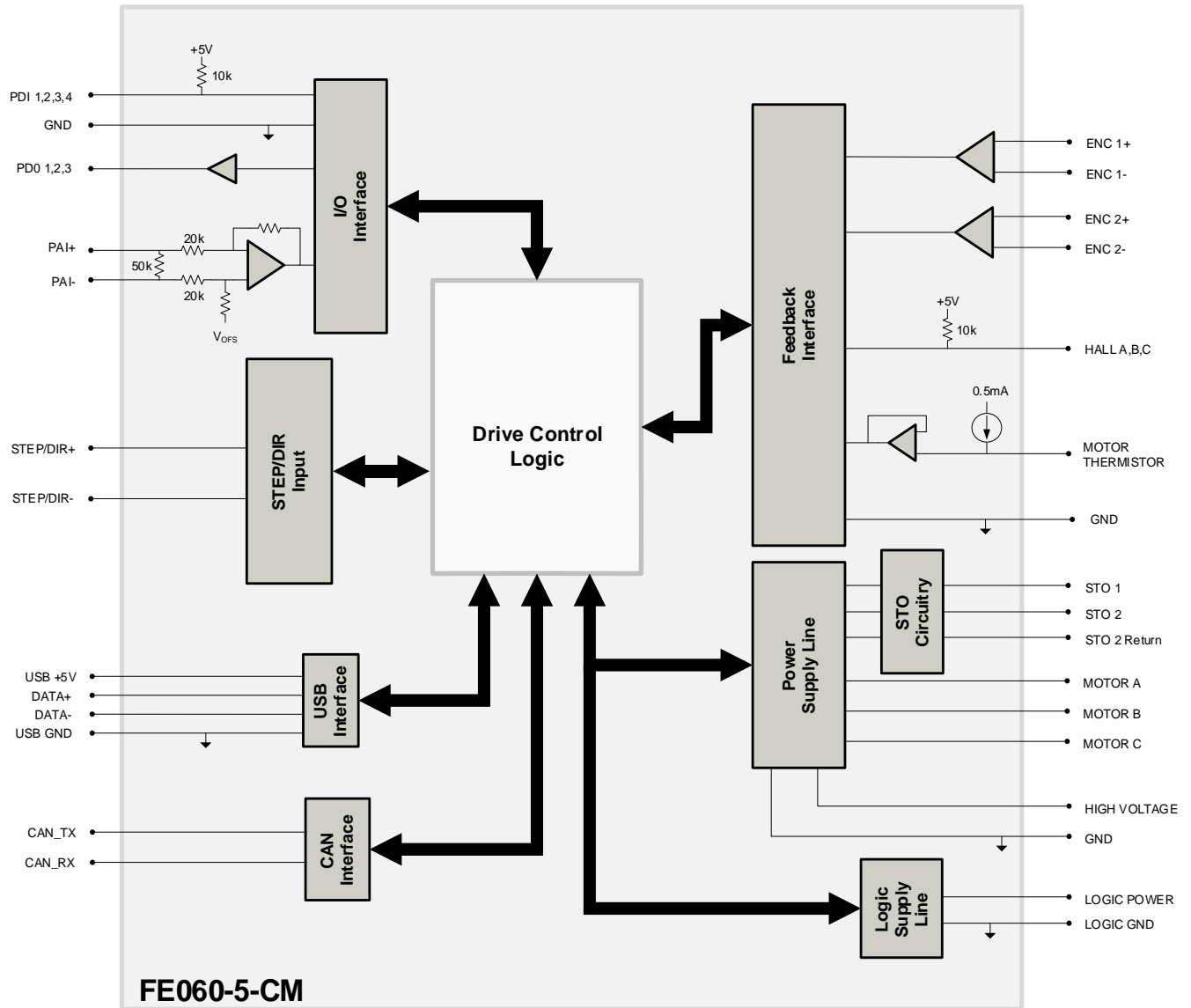

INFORMATION ON APPROVALS AND COMPLIANCES



The RoHS Directive restricts the use of certain substances including lead, mercury, cadmium, hexavalent chromium and halogenated flame retardants PBB and PBDE in electronic equipment.

Sold & Serviced By:



Canadian and International Sales

ELECTROMATE

877-737-8698

sales@electromate.com

www.electromate.com

U.S. Sales

SERVO2GO.com

877-378-0240

sales@servo2go.com

www.servo2go.com

SPECIFICATIONS

Description	Electrical Specifications		Value
	Units		
DC Supply Input Range	VDC	10 – 55	
DC Supply Undervoltage	VDC	8	
DC Supply Overvoltage	VDC	58	
Logic Supply Input Range (optional)	VDC	10 – 55	
Safe Torque Off Voltage (Default)	VDC	5	
Minimum Required External Bus Capacitance	μF	500	
Maximum Peak Current Output ¹	A (Arms)	10 (7.07)	
Maximum Continuous Current Output ²	A (Arms)	5 (5)	
Efficiency at Rated Power	%	99	
Maximum Continuous Output Power	W	272	
Maximum Power Dissipation at Rated Power	W	3	
Minimum Load Inductance (line-to-line) ³	μH	150 (@ 48VDC supply); 75 (@24VDC supply); 40 (@12VDC supply)	
Switching Frequency	kHz	20	
Maximum Output PWM Duty Cycle	%	85	

Description	Control Specifications		Value
	Units		
Communication Interfaces	-	CANopen (USB for configuration)	
Command Sources	-	±10 V Analog, Over the Network, Sequencing, Indexing, Jogging, Step & Direction, Encoder Following	
Feedback Supported	-	Absolute Encoder (BiSS C-Mode, EnDat 2.2), Hall Sensors, Incremental Encoder, Auxiliary Incremental Encoder, ±10 VDC Position, Tachometer (±10V)	
Commutation Methods	-	Sinusoidal, Trapezoidal	
Modes of Operation	-	Profile Modes, Cyclic Synchronous Modes, Current, Velocity, Position, Interpolated Position Mode (PVT)	
Motors Supported ⁴	-	Three Phase (Brushless Servo), Single Phase (Brushed Servo, Voice Coil, Inductive Load), Stepper (2- or 3-Phase Closed Loop), AC Induction (Closed Loop Vector)	
Hardware Protection	-	40+ Configurable Functions, Over Current, Over Temperature (Drive & Motor), Over Voltage, Short Circuit (Phase-Phase & Phase-Ground), Under Voltage	
Programmable Digital Inputs/Outputs	-	4/3	
Programmable Analog Inputs/Outputs	-	1/0	
Primary I/O Logic Level	-	5 VDC, not isolated	
Current Loop Sample Time	μs	50	
Velocity Loop Sample Time	μs	100	
Position Loop Sample Time	μs	100	
Maximum Encoder Frequency	MHz	20 (5 pre-quadrature)	

Description	Mechanical Specifications		Value
	Units		
Size (H x W x D)	mm (in)	38.1 x 25.4 x 11.5 (1.50 x 1.00 x 0.45)	
Weight	g (oz)	19.8 (0.7)	
Ambient Operating Temperature Range ⁵	°C (°F)	0 – 65 (32 – 149)	
Storage Temperature Range	°C (°F)	-40 – 85 (-40 – 185)	
Relative Humidity	-	0-95%, non-condensing	
Form Factor	-	PCB Mounted	
P1 SIGNAL CONNECTOR	-	80-pin 0.4mm spaced connector	
TERMINAL PINS	-	11x Terminal Pins	

Notes

1. Capable of supplying drive rated peak current for 2 seconds with 10 second foldback to continuous value. Longer times are possible with lower current limits.
2. Continuous I_{Arms} value attainable when RMS Charge-Based Limiting is used.
3. Lower inductance is acceptable for bus voltages well below maximum. Use external inductance to meet requirements.
4. Maximum motor speed for stepper motors is 600 RPM. Consult the hardware installation manual for 2-phase stepper wiring configuration.
5. Additional cooling and/or heatsink may be required to achieve rated performance.

PIN FUNCTIONS

P1 – Signal Connector			
Pin	Name	Description / Notes	I/O
1	GROUND	Ground	GND
3	PAI-1+	Differential Programmable Analog Input or Reference Signal Input (12-bit Resolution)	I
5	PAI-1-		I
7	THERMISTOR	Motor Thermal Protection.	I
9	GROUND	Ground	GND
11	ENC 1 DATA+ / A+	Differential Data Line for Absolute Encoders (BiSS: SLO+/-) or Differential Incremental Encoder A.	I/O
13	ENC 1 DATA- / A-		I/O
15	ENC 1 CLK+ / B+	Differential Clock Line for Absolute Encoders (BiSS: MA+/-) or Differential Incremental Encoder B.	I/O
17	ENC 1 CLK- / B-		I/O
19	GROUND	Ground	GND
21	ENC 1 REF+ / I+	Differential Reference Mark for Absolute Encoders (Leave open for BiSS) or Differential Incremental Encoder Index.	I
23	ENC 1 REF- / I-		I
25	CAN_TX	CAN Transmit Line (requires external transceiver)	I/O
27	CAN_RX	CAN Receive Line (requires external transceiver)	I/O
29	CAN STANDBY	Low power CAN mode control	I/O
31	PDI-1	Programmable Digital Input	I
33	PDI-2	Programmable Digital Input	I
35	PDI-3	Programmable Digital Input	I
37	PDI-4	Programmable Digital Input	I
39	GROUND	Ground	GND
41	RESERVED	Reserved. Do not connect.	-
43	RESERVED	Reserved. Do not connect.	-
45	RESERVED	Reserved. Do not connect.	-
47	RESERVED	Reserved. Do not connect.	-
49	RESERVED	Reserved. Do not connect.	-
51	RESERVED	Reserved. Do not connect.	-
53	RESERVED	Reserved. Do not connect.	-
55	RESERVED	Reserved. Do not connect.	-
57	RESERVED	Reserved. Do not connect.	-
59	GROUND	Ground	GND
61	RESERVED	Reserved. Do not connect.	-
63	RESERVED	Reserved. Do not connect.	-
65	RESERVED	Reserved. Do not connect.	-
67	RESERVED	Reserved. Do not connect.	-
69	RESERVED	Reserved. Do not connect.	-
71	RESERVED	Reserved. Do not connect.	-
73	+5V_OUT	+5VDC unprotected supply (See Note 1)	O
75	+5V_USER	+5VDC User Supply for feedback and local logic (See Note 1)	O
77	+5V_USER		O
79	GROUND	Ground	GND

Pin	Name	Description / Notes	I/O
2	GROUND	Ground	GND
4	DATA+ USB	USB Data Channel	I/O
6	DATA- USB		I/O
8	GROUND	Ground	GND
10	SCLA	I ² C Data Signals for Addressing, Network Error LED, and Bridge Status LED. See Hardware Manual for more info.	O
12	SDAA		I/O
14	HALL A		I
16	HALL B	Single-ended Commutation Sensor Inputs	I
18	HALL C		I
20	GROUND	Ground	GND
22	ENC 2 A+	Differential Incremental Encoder A.	I
24	ENC 2 A-		I
26	ENC 2 B+	Differential Incremental Encoder B.	I
28	ENC 2 B-		I
30	ENC 2 I+	Differential Incremental Encoder Index.	I
32	ENC 2 I-		I
34	PDO-1	Programmable Digital Output (TTL/8mA)	O
36	PDO-2	Programmable Digital Output (TTL/8mA)	O
38	PDO-3	Programmable Digital Output (TTL/8mA)	O
40	GROUND	Ground	GND
42	RESERVED	Reserved. Do not connect.	-
44	RESERVED	Reserved. Do not connect.	-
46	RESERVED	Reserved. Do not connect.	-
48	RESERVED	Reserved. Do not connect.	-
50	RESERVED	Reserved. Do not connect.	-
52	RESERVED	Reserved. Do not connect.	-
54	RESERVED	Reserved. Do not connect.	-
56	RESERVED	Reserved. Do not connect.	-
58	RESERVED	Reserved. Do not connect.	-
60	GROUND	Ground	GND
62	RESERVED	Reserved. Do not connect.	-
64	RESERVED	Reserved. Do not connect.	-
66	RESERVED	Reserved. Do not connect.	-
68	STEP	Step Input.	I
70	DIR	Direction Input.	I
72	RESERVED	Reserved. Do not connect.	-
74	RESERVED	Reserved. Do not connect.	-
76	+3V3 OUT	+3.3VDC Supply Output for local logic signals (100 mA max)	O
78	+3V3 OUT		O
80	GROUND	Ground	GND

Connector Information	80-pin, 0.4mm spaced connector
Mating Connector Details	PANASONIC: P/N AXT380224
Mating Connector Included with Drive	No

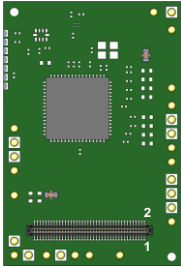

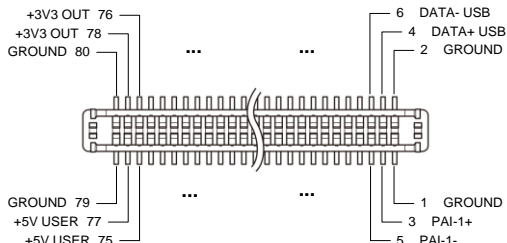

- Notes**
- Total current through pins P1-73/75/77 should not exceed 300mA, while no single pin should be loaded more than 150mA.

Drive Status LED and Node Addressing

SCLA (P1-10); SDAA (P1-12)
 The SCLA and SDAA pins allow Drive Status LED monitoring and Node Addressing to be performed with an I²C bus I/O expander. For more information on how to utilize and configure the I/O expander into an interface board, consult the hardware installation manual.

TERMINAL PIN LOCATIONS

The 11 Terminal Pins provide connection to the high power drive signals. Terminal Pins must be soldered to an interface board.

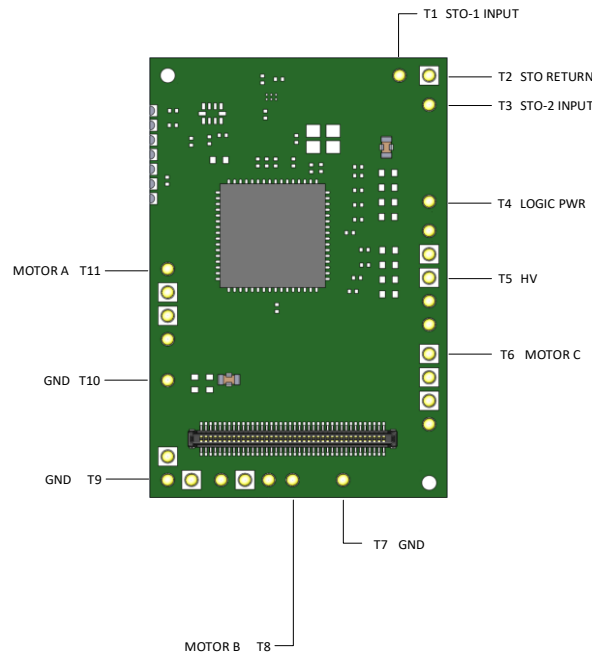

Pin	Name	Description / Notes	I/O
T1	STO-1 INPUT	Safe Torque Off – Input 1	I
T2	STO RETURN	Safe Torque Off Return	STORET
T3	STO-2 INPUT	Safe Torque Off – Input 2	I
T4	LOGIC PWR	Logic Supply Input (10 – 55VDC) (optional)	I
T5	HV	DC Supply Input (10 - 55 VDC). Minimum 500µF external capacitance required between HV and POWER GND.	I
T6	MOTOR C	Motor Phase C. All provided motor phase output pins must be used.	O
T7	GND	Ground.	GND
T8	MOTOR B	Motor Phase B. All provided motor phase output pins must be used.	O
T9	GND	Ground.	GND
T10	GND		GND
T11	MOTOR A	Motor Phase A. All provided motor phase output pins must be used.	O

Terminal Pin Details

Safe Torque Off (STO) Inputs

The Safe Torque Off (STO) inputs are dedicated +5VDC sinking single-ended inputs. For applications not using STO functionality, disabling of the STO feature is required for proper drive operation. STO may be disabled by following the STO Disable wiring instructions as given in the hardware installation manual. Consult the hardware installation manual for more information.

Sold & Serviced By:



Canadian and International Sales

ELECTROMATE

877-737-8698

sales@electromate.com

www.electromate.com

U.S. Sales



877-378-0240

sales@servo2go.com

www.servo2go.com

MOUNTING DIMENSIONS

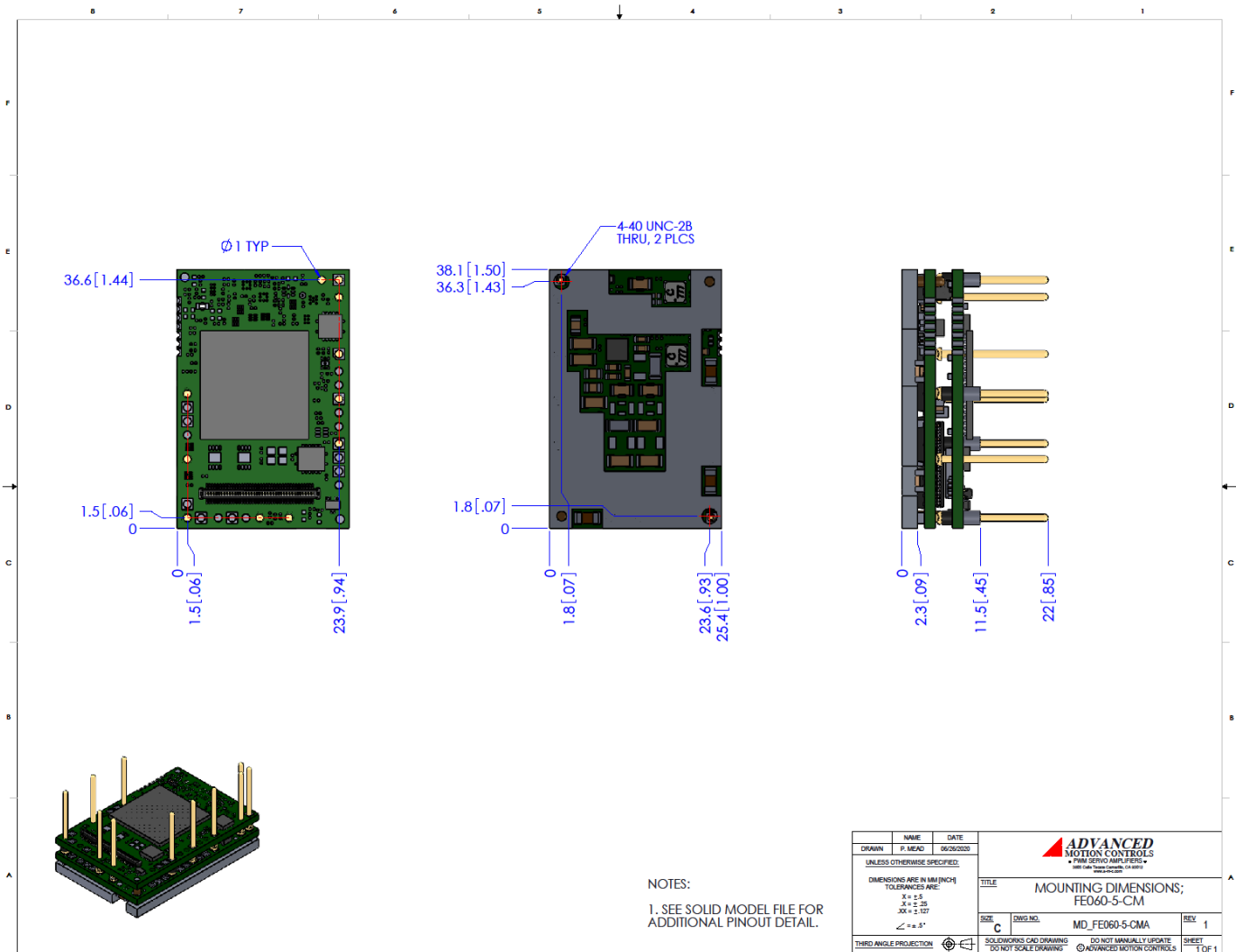

DRAWN	NAME	DATE
	J. MENDO	06/26/2020
UNLESS OTHERWISE SPECIFIED:		
DIMENSIONS ARE IN MM (INCH)		
TOLERANCES ARE		
X = ±.5		
Y = ±.25		
Z = ±.127		
∠ = ±.5°		
THIRD ANGLE PROJECTION		
TITLE		REV
MOUNTING DIMENSIONS; FE060-5-CM		1
SIZE	DWG. NO.	MD_FE060-5-CMA
C		
SOLIDWORKS CAD DRAWING DO NOT SCALE DRAWING		DO NOT MANUALLY UPDATE ADVANCED MOTION CONTROLS
SHEET		T of 1

Sold & Serviced By:

Canadian and International Sales



ELECTROMATE

877-737-8698
sales@electromate.com
www.electromate.com

U.S. Sales



SERVO2GO.com

877-378-0240
sales@servo2go.com
www.servo2go.com

PART NUMBERING AND CUSTOMIZATION INFORMATION

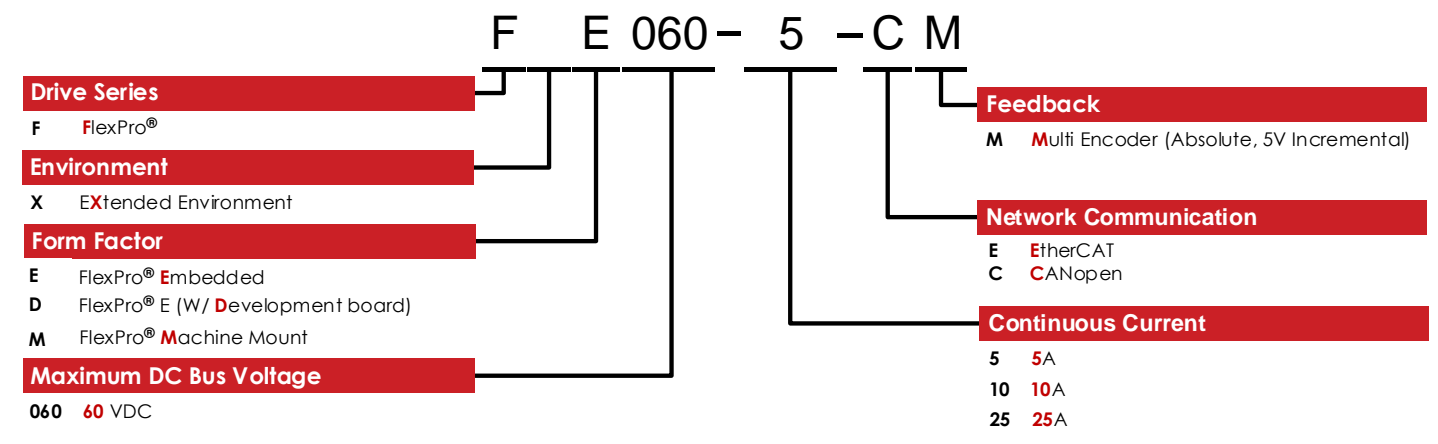

ADVANCED Motion Controls also has the capability to promptly develop and deliver specified products for OEMs with volume requests. Our Applications and Engineering Departments will work closely with your design team through all stages of development in order to provide the best servo drive solution for your system. Equipped with on-site manufacturing for quick-turn customs capabilities, ADVANCED Motion Controls utilizes our years of engineering and manufacturing expertise to decrease your costs and time-to-market while increasing system quality and reliability.

Examples of Customized Products

- | | |
|--|--|
| <ul style="list-style-type: none"> ▲ Optimized Footprint ▲ Private Label Software ▲ OEM Specified Connectors ▲ No Outer Case ▲ Increased Current Resolution ▲ Increased Temperature Range ▲ Custom Control Interface ▲ Integrated System I/O | <ul style="list-style-type: none"> ▲ Tailored Project File ▲ Silkscreen Branding ▲ Optimized Base Plate ▲ Increased Current Limits ▲ Increased Voltage Range ▲ Conformal Coating ▲ Multi-Axis Configurations ▲ Reduced Profile Size and Weight |
|--|--|

Feel free to contact us for further information and details!

Available Accessories

ADVANCED Motion Controls offers a variety of accessories designed to facilitate drive integration into a servo system. Visit www.a-m-c.com to see which accessories will assist with your application design and implementation.

Development Board

The FE060-5-CM is offered in a pre-soldered development board assembly to provide easy connections to motor, power, and signal functions. The development board assembly can be ordered as model number **FD060-5-CM**.



All specifications in this document are subject to change without written notice. Actual product may differ from pictures provided in this document.