

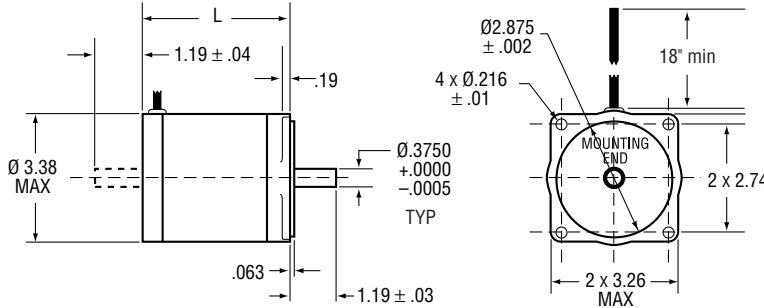

STEP MOTORS

Hybrid Step Motors  
 SIZE 34



Part #	MOTOR CONNECTION			Minimum Holding Torque (oz-in)	Leads	Step Angle	Volts		Amps		Ohms	mH	Rotor Inertia (oz-in <sup>2</sup> /G-CM <sup>2</sup> )	Motor Weight (Lbs.)
	1 = series	2 = parallel	3 = unipolar				Motor Length (inches)	Volts	Amps	Ohms				
4034-322	1			212.0	6	1.8	8.2	1.13	7.2	46.0	3.66/670	3.00		
	3			150.0			5.8	1.60	3.6	11.5				
4034-324	1			212.0			3.5	2.19	1.6	12.0				
	3			150.0			2.5	3.10	0.8	3.0				
4034-326	1			212.0			2.5	3.32	0.8	5.0				
	3			150.0	▽		1.8	4.70	0.4	1.3				
* 5034-348	1			212.0	8		3.0	2.42	1.3	10.0				
	2			212.0			1.5	4.84	0.3	2.5				
	3			150.0	▽		2.1	3.42	0.6	2.5	▽	▽		
4034-329	1			424.0	6		4.2	2.83	1.5	12.0	6.72/1230	5.40		
	3			300.0			3.0	4.00	0.8	3.0				
4034-331	1			424.0			3.5	3.25	1.1	11.0				
	3			300.0	▽		2.5	4.60	0.6	2.8				
* 5034-349	1			447.0	8		3.5	3.54	1.0	11.6				
	2			447.0			1.8	7.07	0.3	2.9				
	3			316.0	▽	▽	2.5	5.00	0.5	2.9	▽	▽		

**OTHER LENGTHS AND WINDINGS AVAILABLE UPON REQUEST**

- Part numbers listed are for single shaft. To order double shaft add 'D' to the end.
- All size 34 motors are optimized for microstepping.
- \* Optimized for use with 160 volt drives.



STEP MOTORS

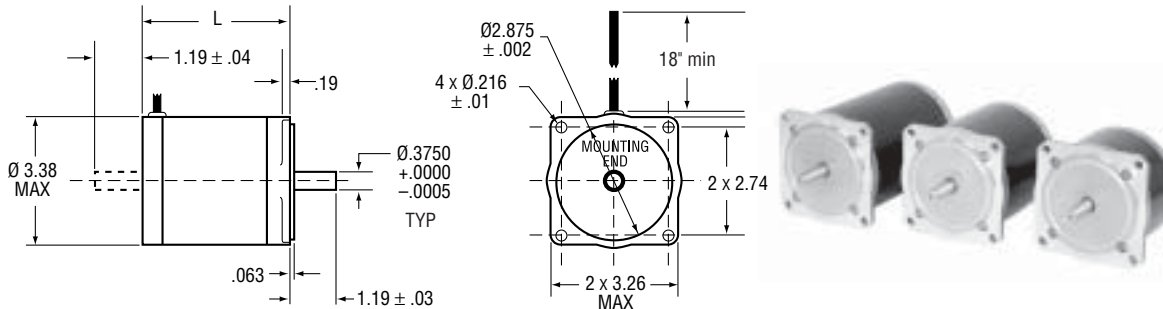

Part #	MOTOR CONNECTION			Minimum Holding Torque (oz-in)	Leads	Step Angle	Volts	Amps	Ohms	mH	Rotor Inertia (oz-in <sup>2</sup> /G-CM <sup>2</sup> )	Motor Weight (Lbs.)
	1 = series	2 = parallel	3 = unipolar									
4034-334	1		5.1	636.0	6	1.8	6.1	2.47	2.4	28.0	10.2/1870	7.70
	3			450.0	6		4.3	3.50	1.2	7.0		
4034-336	1			636.0	6		3.7	3.89	1.0	10.0		
	3			450.0	6		2.6	5.50	0.5	2.5		
4034-338	1			636.0	6		3.4	4.95	0.7	6.8		
	3			450.0	6		2.4	7.00	0.4	1.7		
4034-339	1			636.0	6		2.1	7.78	0.3	2.8		
	3			450.0	6		1.5	11.00	0.1	0.7		
* 5034-350	1			667.0	8		3.5	4.17	0.8	10.4		
	2			667.0	8		1.8	8.34	0.2	2.6		
	3			472.0	8		2.5	5.90	0.4	2.6		

**OTHER LENGTHS AND WINDINGS AVAILABLE UPON REQUEST**

- Part numbers listed are for single shaft. To order double shaft add 'D' to the end.
- All size 34 motors are optimized for microstepping.
- \* Optimized for use with 160 volt drives.

Hybrid Step Motors  
 SIZE 34



# Size 34 Motor

## Typical Speed/Torque Performance\*

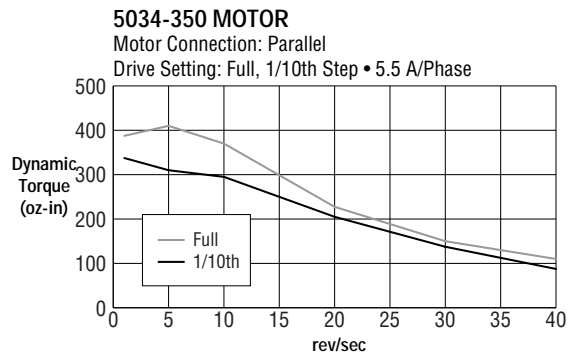
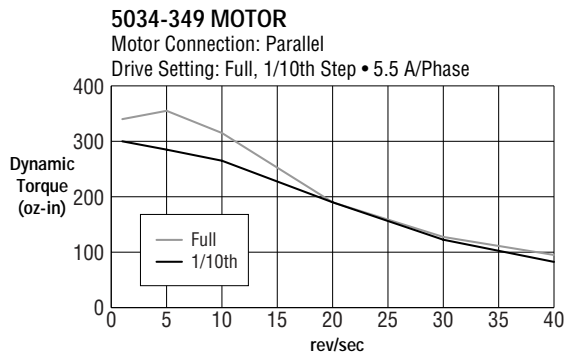
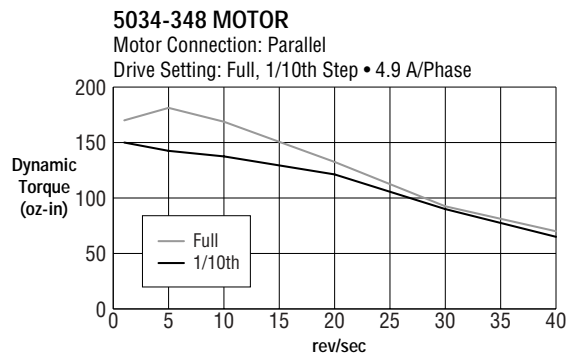
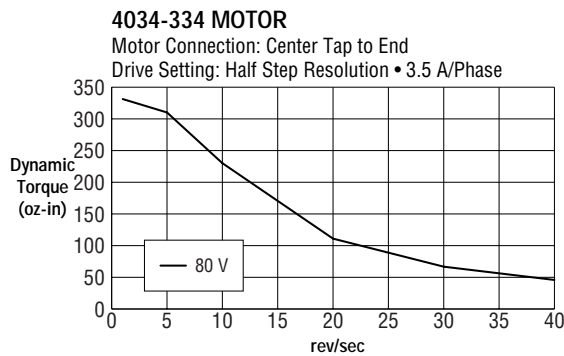
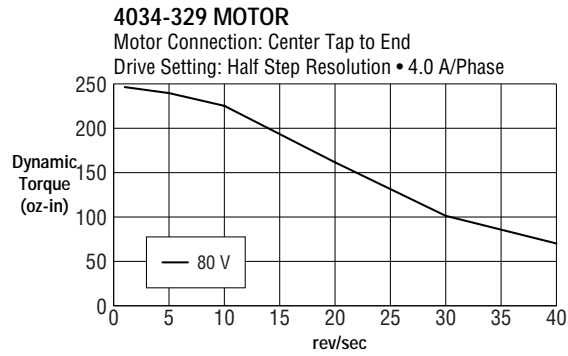
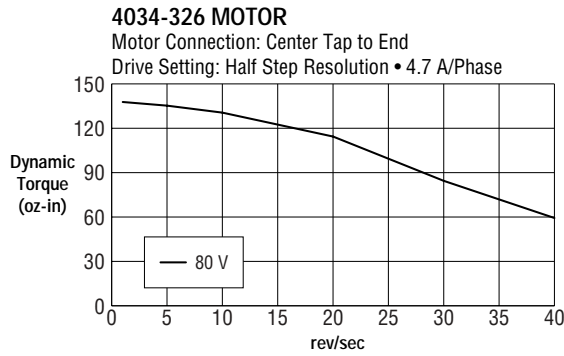

\*Full steps/sec = Rev/sec x 200. Half steps/sec = Rev/sec x 400.