

EPOS2 P programmable positioning controller Summary

Standalone operation



EPOS2 P 24/5 (programmable)

- IEC 61131-3 programmable
- CANopen Master function
- Multiple axis systems via CAN Bus CANopen
- Point to point control unit (1 axis)
- Interpolated Position Mode (PVT)
- DC and EC motors up to 120 W
- 6 digital inputs (TTL and PLC level)
- 4 digital outputs
- 2 analog inputs (12-bit ADC)
- compact design

Details page 334

Standalone operation, programmable from PC via RS232 or USB 2.0 with standard IEC 61131-3. Program languages (ST, IL, FBD, LD, SFC). CANopen master function for controlling other axes. Standard motion control library. Supervisory Control and Data Acquisition for monitoring and controlling a process via RS232; USB 2.0 or CANopen.

Typical applications:

- Work equipment manufacturing
- Tool building
- System automation tasks

Part Number

EPOS2 P 24/5 **378308**

EPOS2 P is a freely programmable positioning controller with an integrated power stage, based on the EPOS2 slave version. It is suitable for brushless and brush DC motors with incremental encoder and up to 120 watt output.

Standalone drive systems

With self-compiled programs, the standalone version of EPOS2 can autonomously control single and multiple axis systems dispensing with the need for a superior intelligent control unit.

Via the CAN Bus all axes can be coordinated simultaneously. The combination with maxon motors produces drive systems for highly dynamic movements.

Standalone

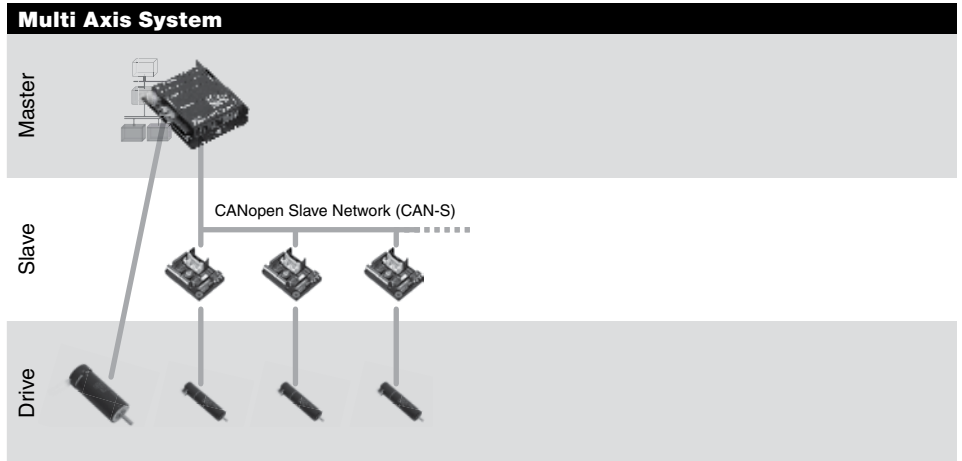
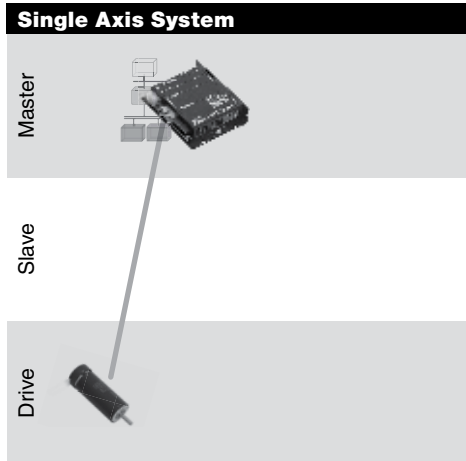

Supervisory Control

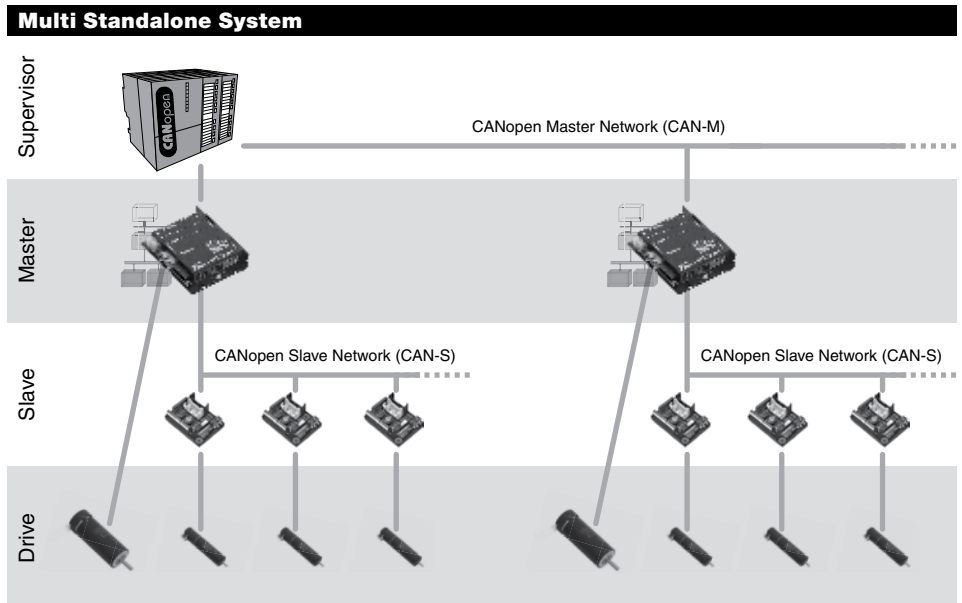
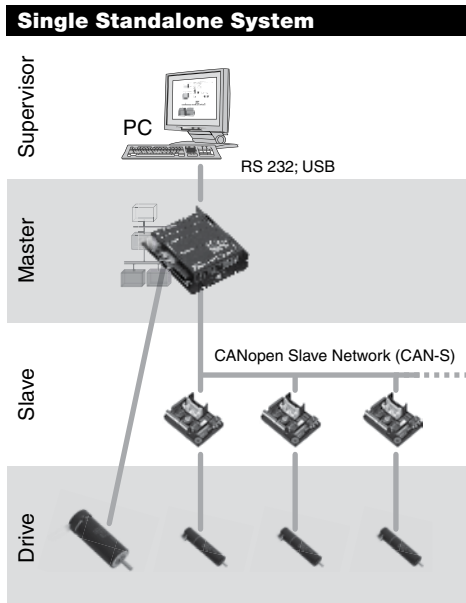

Technology

The programming of applications complies with IEC 61131-3 standard. A non-volatile flash memory is used for saving. The three-stage code optimization produces IEC 61131-3 programs adjusted for the application's needs; optimized by memory, performance or a combination of both.

EPOS Studio – programming according to IEC 61131-3

Editors (ST, IL, FBD, LD, SFC) of the powerful “EPOS Studio” tool are available for programming according to IEC 61131-3. The integrated project browser shows all network resources. Complex programs with a large number of decentralized controls can be optimally managed with it. Drive systems are configured and networked quickly using intelligent step-by-step wizards.

Motion control library

The complexity and development costs of drive systems are substantially reduced. The Motion Firmware Library was implemented according to the widely-used Motion Control Standard. Standardized function blocks make implementation easy.

maxon utility library

Thanks to the additional maxon user library, the programming of recurring motion control tasks is simplified. By means of the “Best Practice” programs and the numerous applications examples, purposeful IEC 61131-3 application programs can be compiled.

Technical data page 334

Performance features

- 32 bit host processor, 60 MHz
- 1 MB memory, with 768 KB free user program memory
- typically 2.5 ms / 5000 lines IL
- 4 KB non-volatile memory
- Digital motion control signal processor

Software features

- Windows-based development environment
- IEC 61131-3 programming languages (ST, IL, FBD, LD, SFC)
- IEC 61131-3 standard libraries
- Motion control function blocks
- maxon utility function block library
- CANopen function block library
- User libraries
- Network variables and data exchange
- Online debugger with break points and watch variables
- Axis configuration and parameterization
- Online help

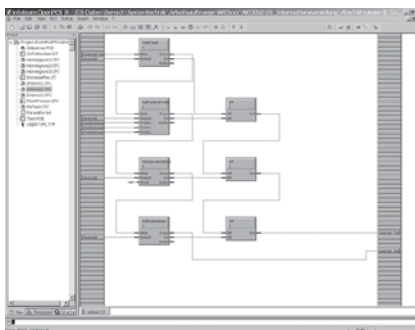

FBD Editor

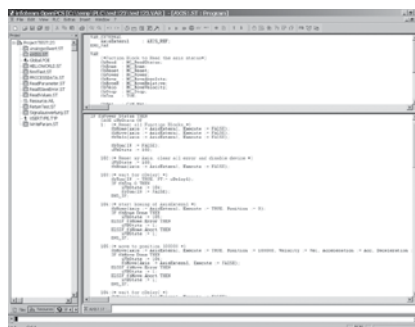

ST Editor

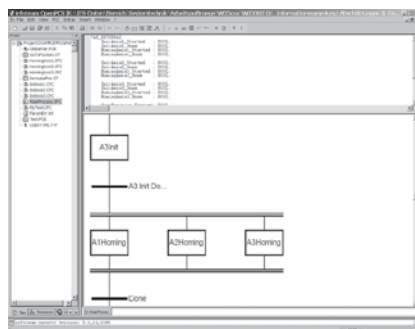

SFC Editor

Motion firmware library

- Drive control
- Referencing (Homing)
- Speed control
- Positioning absolute and relative
- Error Management
- Parameter Handling

Motion utility library

- Inputs and Outputs
- Error Handling
- Object Dictionary Access
- Homing Parameter
- Data Handling

EPOS2 P programmable positioning controller Data

CANopen

USB

RS232

GUI



EPOS2 P 24/5

Matched with DC brush motors with encoder or brushless EC motors with Hall sensors and encoder, from 5 to 120 watts.

Additional information

Controller versions

Master-Version (programmable)

Electrical Data

Operating voltage V_{CC}	11 - 24 VDC
Logic supply voltage V_C (optional)	11 - 24 VDC
Max. output voltage	$0.9 \times V_{CC}$
Max. output current I_{max} (<1 s)	10 A
Continuous output current I_{cont}	5 A
Switching frequency of power stage	50 kHz
Sample rate of PI - current controller	10 kHz
Sample rate of PI - speed controller	1 kHz
Sample rate of PID - positioning control	1 kHz
Max. speed (1 pole pair)	25 000 rpm (sinusoidal); 100 000 rpm (block)
Built-in motor choke per phase	15 μ H / 5 A

Input

Hall sensor signals	H1, H2, H3
Encoder signals	A, A\, B, B\, I, I\ (max. 5 MHz)
Digital inputs	6 (TTL and PLC level)
Analog inputs	2 12-bit resolution, 0...+5 V
CAN-ID (CAN node identification)	Configurable with DIP switch 1...7

Output

Digital outputs	4
Encoder voltage output	+5 VDC, max. 100 mA
Hall sensor voltage output	+5 VDC, max. 30 mA
Auxiliary voltage output	V_{CC} , max. 1300 mA

Interface

RS232	RxD; TxD (max. 115 200 bit/s)
CAN	high; low (max. 1 Mbit/s)
USB 2.0	Data+; Data- (max. 12 Mbit/s)

Indicator

Operating/Error/Program	green LED, red LED, blue LED
-------------------------	------------------------------

Ambient temperature and humidity range

Operation	-10...+45°C
Storage	-40...+85°C
No condensation	20...80%

Mechanical Data

Weight	Approx. 180 g
Dimensions (L x W x H)	105 x 83 x 24 mm
Mounting threads	Flange for M3-screws

Part Numbers

378308 EPOS2 P 24/5

Accessories

309687 DSR 50/5 Shunt regulator

Order accessories separately, see page 339

Operating modes

CANopen Profile Position, Profile Velocity- and Homing Mode

Position, Velocity and Current Mode

Path generating with trapezoidal or sinusoidal profiles

Feed forward for velocity and acceleration

Interpolated Position Mode (PVT)

Sinusoidal or block commutation for EC motors

Communication

Programming interface (Windows) via USB 2.0 or RS232

Communication via CANopen, RS232 or USB 2.0 maxon protocol

Inputs / Outputs

Free configurable digital inputs e.g. for limit switches and reference switches

Free configurable digital outputs e.g. for holding brakes

Free analog inputs

Available software

EPOS Studio
programming according to IEC 61131-3

IEC 61131-3 standard libraries

motion control library

maxon utility function block library

CANopen function block library

maxon utility library

Application Examples

Best Practice Examples

Firmware

Available documentation

Getting Started

Cable Starting Set

Hardware Reference

Firmware Specification

Programming Reference

Application Notes

Cable

A comprehensive range of cables is available as an option. Details can be found on page 339.