

ADVANCED ANTI-BACKLASH SUPERNUTS™

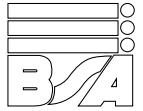

XCM 1800

Introducing our smallest anti-backlash nut design ever. The XCM 1800 uses the same patented ActiveCAM™ mechanism as its larger siblings in a miniaturized package. This allows backlash free operation in space critical applications requiring high accuracy and low drag torque. This cost effective solution is available in either flanged or threaded versions.

Note: See Screw Section on page 2-20 for more information. Specify XCMT or XCMF when ordering, see drawings at right.

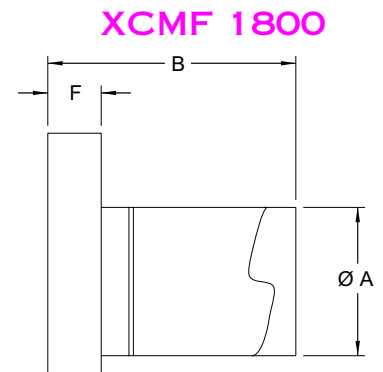
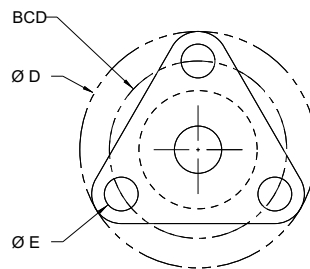
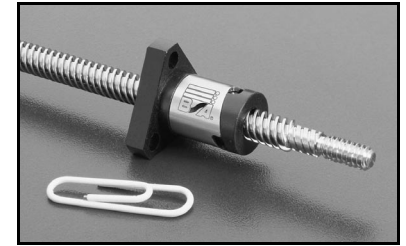
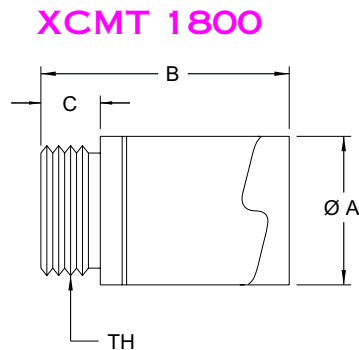

DIA.	LEAD	PART NO.	SUPERNUT DIMENSIONS								DESIGN LOAD	EFFICIENCY %	DRAG TORQUE OZ-IN
			A	B	C	D	E	F	BCD	TH			
3/16"	0.050	XCM_1820	0.50	.90 max	0.200	1.00	0.143	0.18	0.750	7/16-20	5 lbs	49	< 1
6 mm*	1 mm	XCM_6x1										29	
1/4" †	0.0125	XCM_2580										13	
	0.0208	XCM_2548										20	
	0.0250	XCM_2540										23	
	0.0278	XCM_2536										25	
	0.0313	XCM_2532										28	
	0.0357	XCM_2528										30	
1/4"	0.0417	XCM_2524										34	
	0.050	XCM_2520										41	
	0.063	XCM_2516										48	
	0.250	XCM_4-2516										76	
	0.500	XCM_7-2514										81	

* Vee-thread screws, see page 2-22.

† Patent No. 5839321

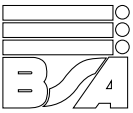

ADVANCED ANTI-BACKLASH SUPERNUTS™



XC 2500

The Cross Cam or XC Model Anti-Backlash assembly is Ball Screws and Actuators' most advanced Anti-Backlash nut design. The unique Patented† ActiveCAM™ accomplishes high axial stiffness, zero backlash and the absolute minimum drag torque. This advantage produces assemblies that cost less, perform better and last longer. The ActiveCAM™ automatically adjusts for wear insuring zero backlash for the life of the nut.

Note: See Screw Section on page 2-20 for more information. Specify XCT or XCF when ordering, see drawings at right.

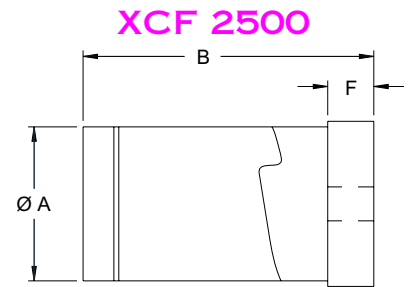
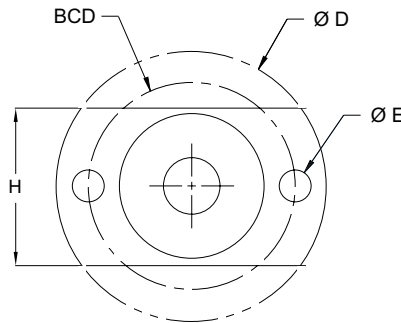
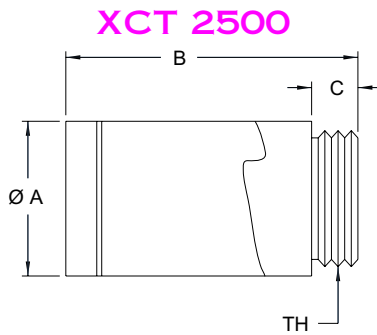

DIA.	LEAD	PART NO.	SUPERNUT DIMENSIONS									DESIGN LOAD	EFFICIENCY %	DRAG TORQUE OZ-IN
			A	B	C	D	E	F	H	BCD	TH			
3/16"	0.050	XC_1820	0.64	1.18 max	0.187	1.19	0.141	0.16	0.66	0.900	9/16-18	10 lbs	49	< 1
6 mm*	1 mm	XC_6x1											29	
1/4" *	0.0125	XC_2580											13	
	0.0208	XC_2548											20	
	0.0250	XC_2540											23	
	0.0278	XC_2536											25	
	0.0313	XC_2532											28	
	0.0357	XC_2528											30	
1/4"	0.0417	XC_2524											34	
	0.050	XC_2520											41	
	0.063	XC_2516											48	
	0.250	XC_4-2516											76	
	0.500	XC_7-2514											81	

* Vee-thread screws, see page 2-22.

† Patent No. 5839321

ADVANCED ANTI-BACKLASH SUPERNUTS™

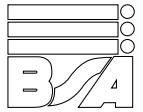

XC 3700

The Cross Cam or XC Model Anti-Backlash assembly is Ball Screws and Actuators' most advanced Anti-Backlash nut design. The unique Patented† ActiveCAM™ accomplishes high axial stiffness, zero backlash and the absolute minimum drag torque. This advantage produces assemblies that cost less, perform better and last longer. The ActiveCAM™ automatically adjusts for wear insuring zero backlash for the life of the nut.

Note: See Screw Section on page 2-20 for more information. Specify either XCT or XCF when ordering, see drawings at right.

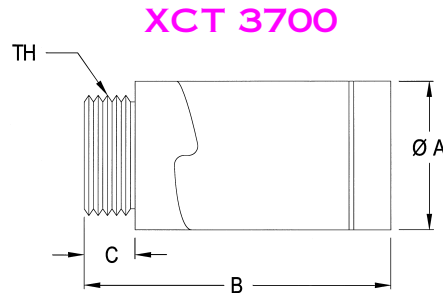

XCF 3700

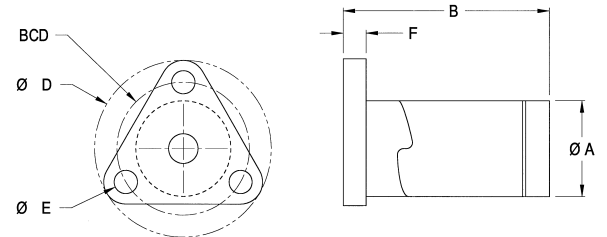

DIA.	LEAD	PART No.	SUPERNUT DIMENSIONS								DESIGN LOAD	EFFICIENCY %	DRAG TORQUE OZ-IN
			A	B	C	D	E	F	TH	BCD			
5/16"	0.083	XC_3112	0.82	1.875 (max)	0.25	1.5	0.2	0.2	5/8" -18	1.125	25 lbs	49	1 - 3
	0.167	XC_2-3112										65	
	0.250	XC_2-3108										72	
	0.500	XC_4-3108										80	
3/8"	0.063	XC_3716										36	
	2mm	XC_37x2M										42	
	0.083	XC_3712										44	
	0.100	XC_3710										49	
	0.125	XC_3708										53	
	0.167	XC_2-3712										60	
	0.200	XC_2-3710										65	
	0.250	XC_2-3708										68	
	0.375	XC_4-3711										75	
0.500	XC_4-3708	79											
10 mm	2mm	XC_10x2M										41	
	3mm	XC_10x3M										53	
	6mm	XC_4-10x1.5M	67										
	20mm	XC_6-10x3.3M	81										

† Patent No. 5839321

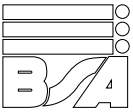

ADVANCED ANTI-BACKLASH SUPERNUTS™



XC 5000

The XC 5000 utilizes the same Patented† ActiveCAM™ as found in the XC 3700 model. Along with the very low drag torque and high axial stiffness advantages, the XC 5000 has greater load capacity.

Note: See Screw Section on page 2-20 for more information. Specify either XCT or XCF when ordering, see drawings at right.

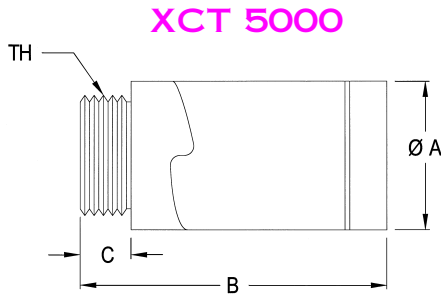

XCF 5000

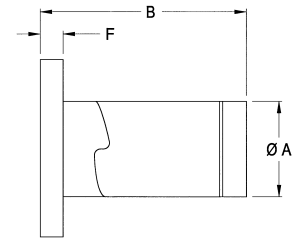
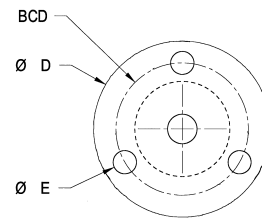

DIA.	LEAD	PART NO.	SUPERNUT DIMENSIONS								DESIGN LOAD	EFFICIENCY %	DRAG TORQUE OZ-IN
			A	B	C	D	E	F	TH	BCD			
7/16"	0.125	XC_2-4316	1.12	2.25 (max)	0.375	1.75	0.2	0.3	15/16-16	1.406	125 lbs	55	1 - 3
	0.250	XC_2-4308										65	
	0.500	XC_4-4308										76	
12mm	5mm	XC_2-12x2.5M										59	
	10mm	XC_4-12x2.5M										73	
1/2"	.0625	XC_5016										30	
	0.100	XC_5010										41	
	0.200	XC_2-5010										57	
	0.250	XC_2-5008										62	
	0.500	XC_4-5008										75	
	0.800	XC_8-5010	80										
	1.000	XC_8-5008	81										

† Patent No. 5839321

ADVANCED ANTI-BACKLASH SUPERNUTS™

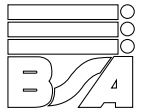

XC 6200

The XC 6200 utilizes the same Patented† ActiveCAM™ as found in the XC 5000 model. Along with the very low drag torque and high axial stiffness advantages, the XC 6200 has greater load capacity.

Note: See Screw Section on page 2-20 for more information. Specify either XCT or XCF when ordering, see drawings at right.

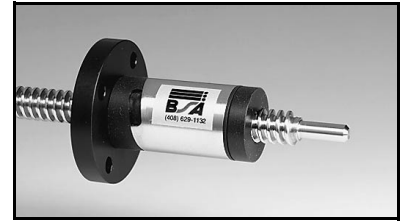
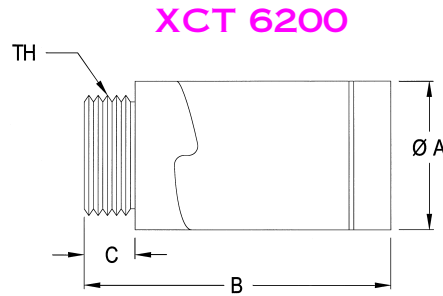

XCF 6200

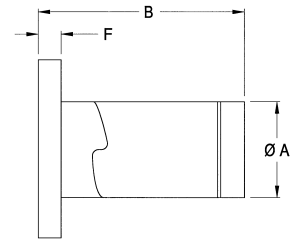
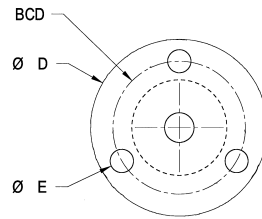

DIA.	LEAD	PART NO.	SUPERNUT DIMENSIONS									EFFICIENCY %	DRAG TORQUE OZ-IN
			A	B	C	D	E	F	TH	BCD	DESIGN LOAD		
5/8"	0.100	XC_6210	1.40	2.60 (max)	0.5	2.13	0.22	0.5	1.25-16	1.688	175 lbs	35	2 - 6
	0.125	XC_6208										40	
	4mm	XC_62x4M										46	
	0.200	XC_2-6210										51	
	0.250	XC_2-6208										57	
	0.500	XC_4-6208										71	
16mm	4mm	XC_16x4M										47	

† Patent No. 5839321

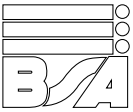

ADVANCED ANTI-BACKLASH SUPERNUTS™



XC 7500

The XC 7500 utilizes BSA's Patented† ActiveCAM™ technology to provide very low drag torque, high axial stiffness and maximum wear life. This self compensating design produces excellent positional repeatability while insuring consistent performance for the long run.

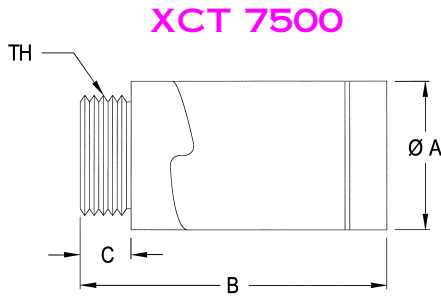

Note: See Screw Section on page 2-20 for more information.

FLANGE F75 (SEE PAGE 8-7)

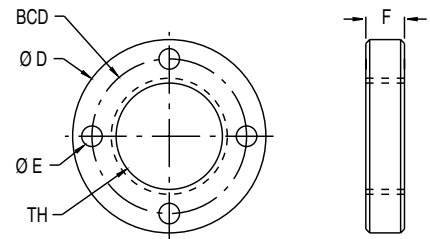

DIA.	LEAD	PART NO.	NUT DIMENSIONS			TH	FLANGE DIMENSIONS (OPTIONAL)				DESIGN LOAD	EFFICIENCY %	DRAG TORQUE OZ-IN
			A	B	C		D	E	F	BCD			
3/4"	0.100	XCT7510	1.63	2.9 (max.)	0.5	1 3/8-16	2.5	0.27	0.50	2.00	250 lbs	31	3 - 10
	0.125	XCT7508										36	
	0.167	XCT7506										44	
	0.200	XCT7505										49	
	0.500	XCT5-7510										69	
	1.000	XCT8-7508										79	
	2.000	XCT10-7505										82	
20mm	4mm	XCT20x4M									41		

† Patent No. 5839321

ADVANCED ANTI-BACKLASH SUPERNUTS™

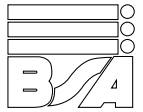

XC 10000

The XC 10000 utilizes BSA's Patented† ActiveCAM™ technology to provide very low drag torque, high axial stiffness and maximum wear life. This self compensating design produces excellent positional repeatability while insuring consistent performance for the long run.

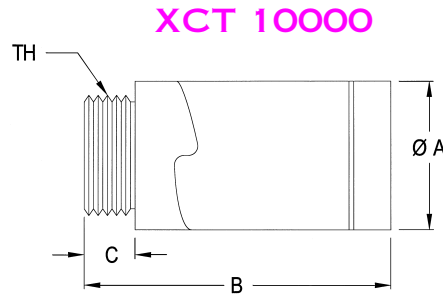

Note: See Screw Section on page 2-20 for more information.

FLANGE F100 (SEE PAGE 8-7)

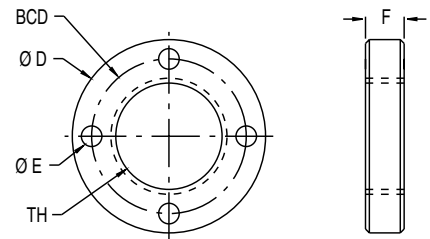

DIA.	LEAD	PART NO.	NUT DIMENSIONS			TH	FLANGE DIMENSIONS (OPTIONAL)				DESIGN LOAD	EFFICIENCY %	DRAG TORQUE OZ-IN
			A	B	C		D	E	F	BCD			
24mm	5mm	XCT24x5M	1.88	3.0 (max.)	0.60	1 9/16-18	3.0	0.27	0.60	2.37	350 lbs	42	5 - 15
1"	0.100	XCT1010										25	
	0.125	XCT1008										29	
	0.200	XCT1005										41	
	0.250	XCT1004										47	
	0.500	XCT5-1010										61	
	1.000	XCT10-1010										74	

† Patent No. 5839321

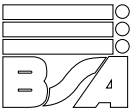

PRECISION LEAD SCREWS & SUPERNUTS™



FEATURES/ADVANTAGES

LOW COST

Considerable savings when compared to ball screw assemblies.

VARIETY

Largest range of leads and diameters 3/16" to 4" to match your requirements.

LUBRICATION

Internally lubricated plastic nuts will operate without lubrication. However, additional lubrication or PTFE coating of the screw is recommended. See page 8-4.

VIBRATION AND NOISE

No ball recirculating vibration and often less audible noise compared to ball screws.

CUSTOM

Option of custom designs to fit into your design envelope.

NON-CORROSIVE*

Stainless Steel and internally lubricated Acetal.

ENVIRONMENT

Less susceptible to particulate contamination compared to ball screws.

LIGHTWEIGHT

Less mass to move.

DESIGN CONSIDERATIONS

LOAD

Supernuts provide a cost effective solution for moderate to light loads. For vertical applications, anti backlash supernuts should be mounted with thread/flange on the bottom.

CANTILEVERED LOADS

Cantilevered loads that might cause a moment on the nut will cause premature failure. Refer to Precision Linear Rails for our complete line-up of linear guides or our stage selection in **Section 4**, **Section 5** and **Section 6** for a complete linear motion solution.

COLUMN LOADING

Refer to column loading chart on page 9-3.

CRITICAL SPEED

Refer to critical speed chart on page 9-2.

SELF-LOCKING

Lead screws can be self locking at low leads. Generally, the lead of the screw should be more than 1/3 of the diameter to satisfactorily backdrive.

TEMPERATURE

Ambient and friction generated heat are the primary causes of premature plastic nut failure. Observe the temperature limits below and discuss your design with our application engineers for continuous duty, high load and high speed applications. BS&A recommends bronze nuts for very high temperature environments or can aid in your selection of high temperature plastic for a custom assembly.

EFFICIENCY

Except at very high leads, efficiency increases as lead increases. Although the internally lubricated Acetal provides excellent lubricity, Ball Screw Assemblies remain significantly more efficient than any Acme design.

LENGTH LIMITATIONS

3/16" to 1/4"	3'
5/16" to 10mm	4'
7/16" to 5/8"	6'
> 5/8"	12'

LEAD ACCURACY

Standard Grade (SRA)	.010 in/ft
Precision Grade (SPR)	.003 in/ft

MATERIAL PROPERTIES

ASSEMBLY		SCREWS	NUTS**			
MAXIMUM TEMPERATURE	FRICTION COEFFICIENT	MATERIAL	MATERIAL	TENSILE STRENGTH	WATER ABSORPTION (24 HRS %)	THERMAL EXPANSION COEFFICIENT
180°F	0.08–0.14	Stainless Steel*	Acetal with PTFE	8,000 psi	0.15	5.4 x 10 ⁻⁵ in/in/°F

*Other materials available on a custom basis.

**Plastic nuts only. See bronze nut section for information on our bronze nut products, page 2-18.



OVERVIEW

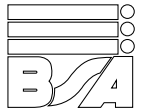

PRECISION LEAD SCREWS & SUPERNUTS™



Rolled Acme lead screws are an excellent economical solution for your linear motion requirements. For over 15 years Ball Screws and Actuators has manufactured the highest quality lead screw assemblies. Our precision rolling machines ensure accurate positioning to 0.003 in/ft and our PTFE coating process produces assemblies that have less drag torque and last longer.

Ball Screws and Actuators provides a large array of standard plastic nut assemblies in anti-backlash or standard Supernut™ designs. For significantly higher loads, standard bronze nuts are available. BS&A also provides engineering design services to aid in your custom design requirements producing a lead—screw assembly to your specifications.

With the introduction of our new unique patent pending Zero-Backlash designs, BS&A provides assemblies with high axial stiffness, zero backlash and the absolute minimum drag torque to reduce motor requirements. These designs produce products that cost less, perform better and last longer. Both automatically adjust for wear insuring zero backlash for the life of the nut.

Our large selection of standard plastic nut assemblies all use an internally lubricated Acetal providing excellent lubricity and wear resistance with or without lubrication. For bronze nuts, BS&A uses SAE 660 bearing bronze which provides high load capacity with good PV performance.

BS&A offers end machining to your specification or can provide you with stock bearing mount, motor mount or complete stage assemblies as shown in **Section 4**.