

# 300 & 400 Series Positioning Tables

300 Series Introduction _____	L-2
400 Series Introduction _____	L-3
Specifications _____	L-5
300 Series Dimensions _____	L-6
400 Series Dimensions _____	L-7
300 Series Motor Couplings _____	L-8
300 Series NEMA 34 Option _____	L-9
Home Switch Options _____	L-10



Sold & Serviced By:

**SERVO2GO.com**

Toll Free Phone: 877-378-0240

Toll Free Fax: 877-378-0249

sales@servo2go.com

www.servo2go.com

### Single Axis Rotary Table

LINTECH's 300 series positioning tables offer precision performance and design flexibility for use in a wide variety of Motion Control applications.

- *Welding*
- *Test Stands*
- *Part Insertion*
- *Laser Positioning*
- *Liquid Dispensing*
- *Semiconductor Processing*
- *Gluing*
- *Pick & Place*
- *Part Scanning*
- *Inspection Stations*
- *General Automation*

### Quality Construction

These tables feature a rigid pair of quality angular contact bearings which produce smooth table top rotation. The low backlash precision worm gear drive provides exceptional accuracy and repeatability. Load capacities to 225 pounds (102 kg) are available, with table top diameters of 6, 8, 10, and 12 inches. All aluminum components have a black anodized finish and each table has a standard NEMA 23 motor mount. Threaded steel inserts in the table top provide for easy mounting of the user load, while the 0.75 inch (19 mm) diameter through hole provides easy access from below. With 3 different gear ratios for each table top, the 300 series tables perform well in either high speed or high resolution applications. Mounting a 300 series rotary table directly to any of LINTECH's linear positioning tables, produces a unique multi-axis system.

### Standard Features - 300 Series

- Worm gear drive
- NEMA 23 & 34 motor mounts
- Standard & Precision versions
- 45, 90, & 180:1 gear reductions
- Load capacity to 225 lbs (102 kg)
- 30 revs/sec maximum input speed
- 10 arc-sec unidirectional repeatability
- 6, 8, 10, & 12 inch table top diameters
- CAD drawings available via the internet
- 0.75 inch (19 mm) diameter through hole
- English & Metric inserts for load mounting

### 300 Series

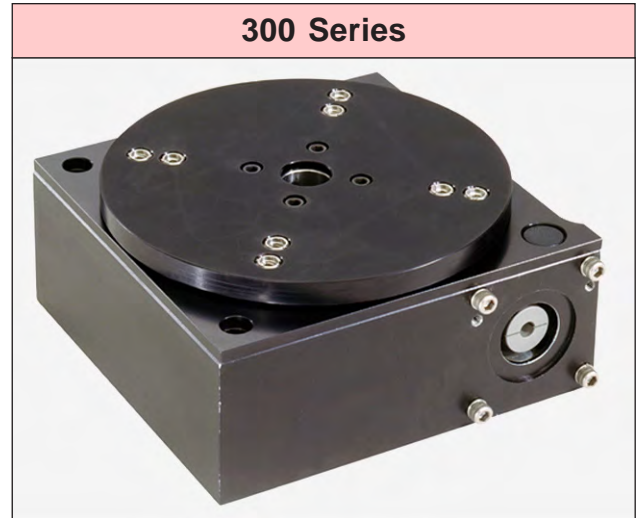

Sold & Serviced By:

**SERVO2GO.com**

Toll Free Phone: 877-378-0240

Toll Free Fax: 877-378-0249

sales@servo2go.com

www.servo2go.com

### Single Axis Rotary Table

LINTECH's 400 series positioning tables offer precision performance and design flexibility for use in a wide variety of Motion Control applications.

- |                                   |                              |
|-----------------------------------|------------------------------|
| □ <i>Welding</i>                  | □ <i>Gluing</i>              |
| □ <i>Test Stands</i>              | □ <i>Pick &amp; Place</i>    |
| □ <i>Part Insertion</i>           | □ <i>Part Scanning</i>       |
| □ <i>Laser Positioning</i>        | □ <i>Inspection Stations</i> |
| □ <i>Liquid Dispensing</i>        | □ <i>General Automation</i>  |
| □ <i>Semiconductor Processing</i> |                              |

### Quality Construction

These tables feature a rigid pair of 4 point contact radial bearings which produce smooth table top rotation. The low backlash precision worm gear drive provides years of exceptional accuracy and repeatability. This rugged construction offers load capacities to 1000 pounds (453 kg) with a 5.48 inch (139 mm) table top diameter. Threaded steel inserts in the table top provide for easy mounting of the user load, while the 4.5 inch (114 mm) diameter through hole provides easy access from below. The NEMA 34 mount can be rotated 360 degrees around either side of the table. With 5 different gear ratios, the 400 series tables perform well in either high speed or high resolution applications.

### Standard Features - 400 Series

- Worm gear drive
- NEMA 34 motor mount
- Standard & Precision versions
- English inserts for load mounting
- 9 revs/sec maximum input speed
- Load capacity to 1,000 lbs (453 kg)
- 12 arc-sec unidirectional repeatability
- 5.48 inch (139 mm) table top diameter
- CAD drawings available via the internet
- 4.5 inch (114 mm) diameter through hole
- 30, 90, 180, 270, & 360:1 gear reductions

### 400 Series



Sold & Serviced By:

**SERVO2GO.com**

Toll Free Phone: 877-378-0240

Toll Free Fax: 877-378-0249

sales@servo2go.com

www.servo2go.com

Specifications subject to change without notice

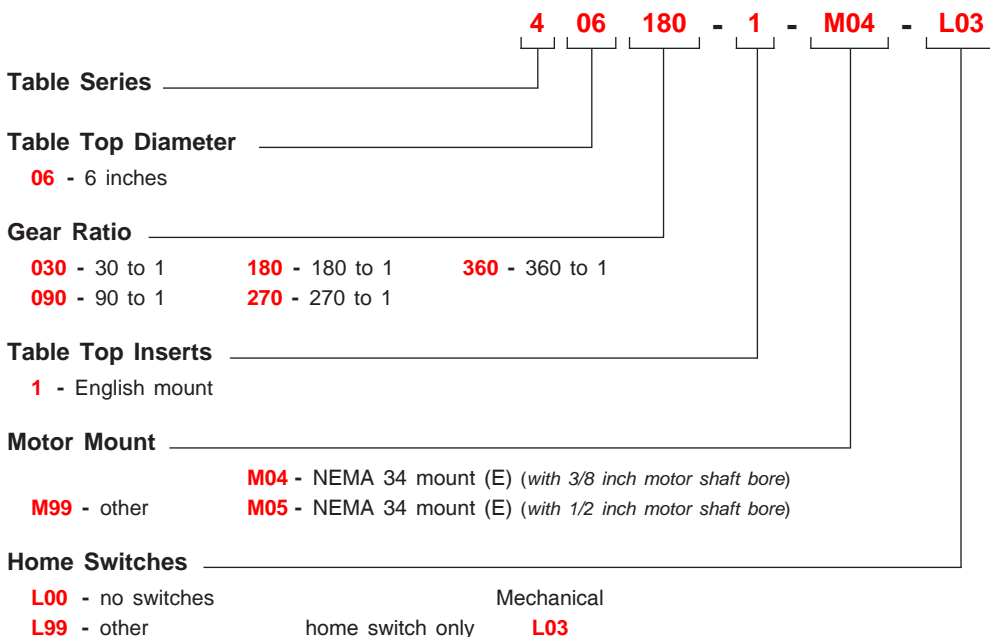
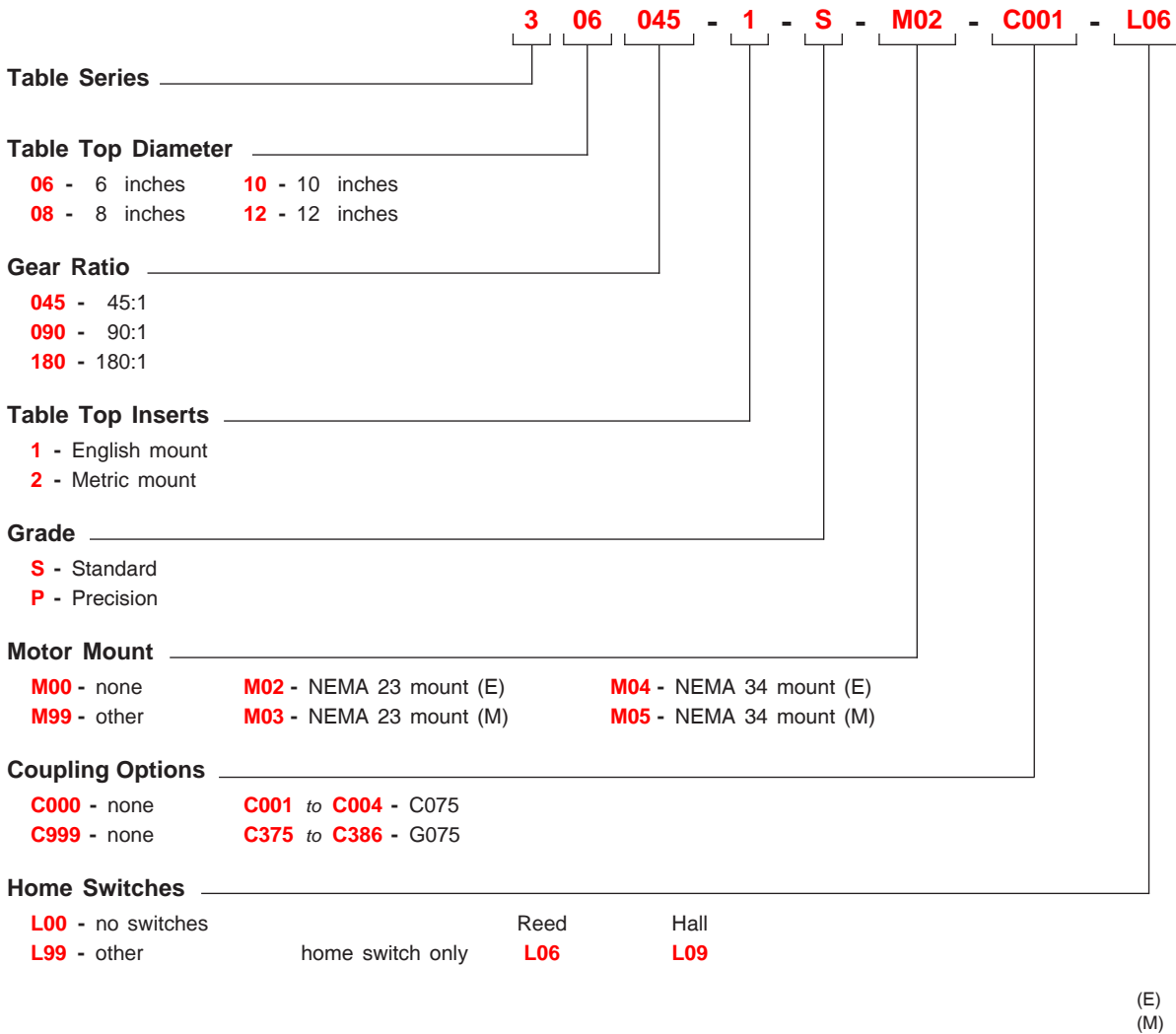

Sold & Serviced By:



Toll Free Phone: 877-378-0240

Toll Free Fax: 877-378-0249

sales@servo2go.com

www.servo2go.com

(E) - English Interface

## Specifications

Load Capacities	300 series <sup>(1)</sup>	400 series <sup>(1)</sup>
<b>Dynamic Horizontal</b> (1 million revs)	225 lbs ( 102 kg)	1000 lbs ( 453 kg)
<b>Dynamic Inverted</b> (1 million revs)	100 lbs ( 45 kg)	1000 lbs ( 453 kg)
<b>Static Horizontal</b>	250 lbs ( 113 kg)	1000 lbs ( 453 kg)
<b>Dynamic Moment</b> (1 million revs)	20 ft-lbs ( 27 N-m)	225 ft-lbs ( 305 N-m)
<b>Static Moment</b>	25 ft-lbs ( 34 N-m)	250 ft-lbs ( 339 N-m)
<b>Maximum Input Speed</b>	30 rev/sec	9 rev/sec
<b>Maximum Input Acceleration</b>	75 rev/sec <sup>2</sup>	50 rev/sec <sup>2</sup>
<b>Maximum Input Torque</b>	125 oz-in (0,88 N-m)	1,000 oz-in (7,06 N-m)

Other	300 series	400 series
<b>Table Material</b>	Base & Table Top - 6061 black anodized aluminum	
<b>Worm Wheel Type</b>	Bronze (AGMA - class 10)	
<b>Worm Gear Type</b>	Steel (AGMA - class 10)	
<b>Duty Cycle</b>	60 %	
(gear ratio)	45:1      90:1      180:1	30:1    90:1    180:1    270:1    360:1
<b>Maximum Table Top Speed</b>	40 rpm      20 rpm      10 rpm	18 rpm    6 rpm    3 rpm    2 rpm    1.5 rpm
<b>Worm Gear Efficiency</b>	50 %      60 %      70 %	50 %    60 %    60 %    60 %    60 %
<b>Worm Gear Inertia</b> (oz-in <sup>2</sup> )	11.5      11.5      11.5	38.6    38.6    50.2    61.7    73.3
<b>Accuracy</b>	< 150 arc-sec	< 180 arc-sec
<b>Unidirectional Repeatability</b>	< 10 arc-sec	< 12 arc-sec
<b>Bidirectional Repeatability</b>	< 40 arc-sec	< 42 arc-sec
<b>Backlash</b>	< 30 arc-sec	< 30 arc-sec
<b>Runout (vertical runout)</b>	Standard < 0.003 in (0,076 mm) <sup>(2)</sup> Precision < 0.001 in (0,025 mm) <sup>(2)</sup>	< 0.002 in (0,05 mm) <sup>(3)</sup>
<b>Concentricity (radial runout)</b>	Standard < 0.003 in (0,076 mm) <sup>(4)</sup> Precision < 0.001 in (0,025 mm) <sup>(4)</sup>	< 0.002 in (0,05 mm) <sup>(5)</sup>
<b>Wobble (axis runout)</b>	Standard < 80 arc-sec <sup>(6)</sup> Precision < 40 arc-sec <sup>(6)</sup>	< 60 arc-sec <sup>(6)</sup>
<b>Breakaway Torque</b>	< 20 oz-in (0,141 N-m)	< 60 oz-in (0,424 N-m)

### Footnotes:

- (1) Dynamic load capacities & life are limited by the stresses exerted upon the worm gear assembly.
- (2) Measured at 6 inches (152,4 mm) from table top center. Total indicator runout.
- (3) Measured at 5.5 inches (139,7 mm) from table top center. Total indicator runout.
- (4) Measured at 0.75 inches (19,1 mm) from table top center. Total indicator runout.
- (5) Measured at 4.5 inches (114,3 mm) from table top center. Total indicator runout.
- (6) Based on the centerline of the table top.

Sold & Serviced By:



Toll Free Phone: 877-378-0240

Toll Free Fax: 877-378-0249

sales@servo2go.com

www.servo2go.com

## Dimensions & Specifications

Model Number	Table Dimensions inches (mm)				Mounting Dimensions inches (mm)					Table Top Weight	Table Weight
	A	B	C	D	E	F	G	H	I	lbs (kg)	lbs (kg)
<b>306xxx-1-S</b>	6.000 (152,4)	0.375 (9,5)	2.500 (63,5)	2.930 (74,4)	5.000 (127,0)	4.000 (101,6)	2.500 (63,5)	6.000 (152,4)	2.000 (50,8)	1.1 (0,5)	11.0 (5,0)
<b>308xxx-1-S</b>	8.000 (203,2)	0.500 (12,7)	2.500 (63,5)	3.055 (77,6)	6.000 (152,4)	4.000 (101,6)	2.500 (63,5)	6.000 (152,4)	2.000 (50,8)	2.5 (1,2)	12.0 (5,4)
<b>310xxx-1-S</b>	10.000 (254,0)	0.750 (19,0)	2.650 (67,3)	3.455 (87,8)	8.000 (203,2)	6.000 (152,4)	4.500 (114,3)	10.000 (254,0)	0.250 (6,3)	5.7 (2,6)	33.0 (15,0)
<b>312xxx-1-S</b>	12.000 (304,8)	0.750 (19,0)	2.650 (67,3)	3.455 (87,8)	10.000 (254,0)	8.000 (203,2)	4.500 (114,3)	10.000 (254,0)	0.250 (6,3)	7.2 (3,3)	36.0 (16,3)

- xxx = 045; 45 to 1 gear ratio
- xxx = 090; 90 to 1 gear ratio
- xxx = 180; 180 to 1 gear ratio

## Dimensions

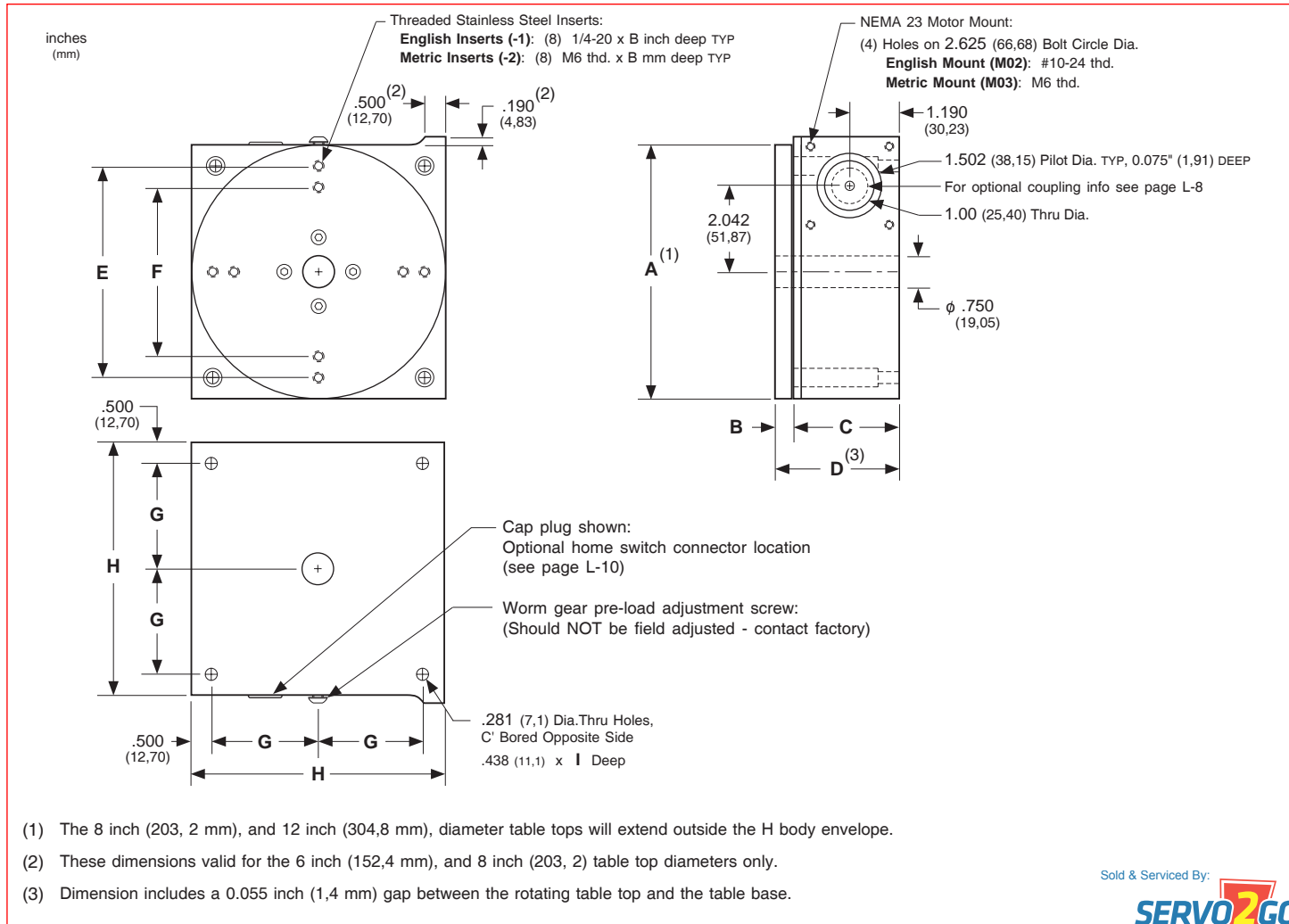

Sold & Serviced By:



Toll Free Phone: 877-378-0240

Toll Free Fax: 877-378-0249

sales@servo2go.com

www.servo2go.com

## Dimensions & Specifications

Model Number	Table Top Diameter inches (mm)	Table Top Weight lbs (kg)	Table Weight lbs (kg)
<b>406xxx-1</b>	5.480 (139,2)	3.0 (1,4)	13.5 (6,2)

- xxx = 030; 30 to 1 gear ratio
- xxx = 090; 90 to 1 gear ratio
- xxx = 180; 180 to 1 gear ratio
- xxx = 270; 270 to 1 gear ratio
- xxx = 360; 360 to 1 gear ratio

## Dimensions

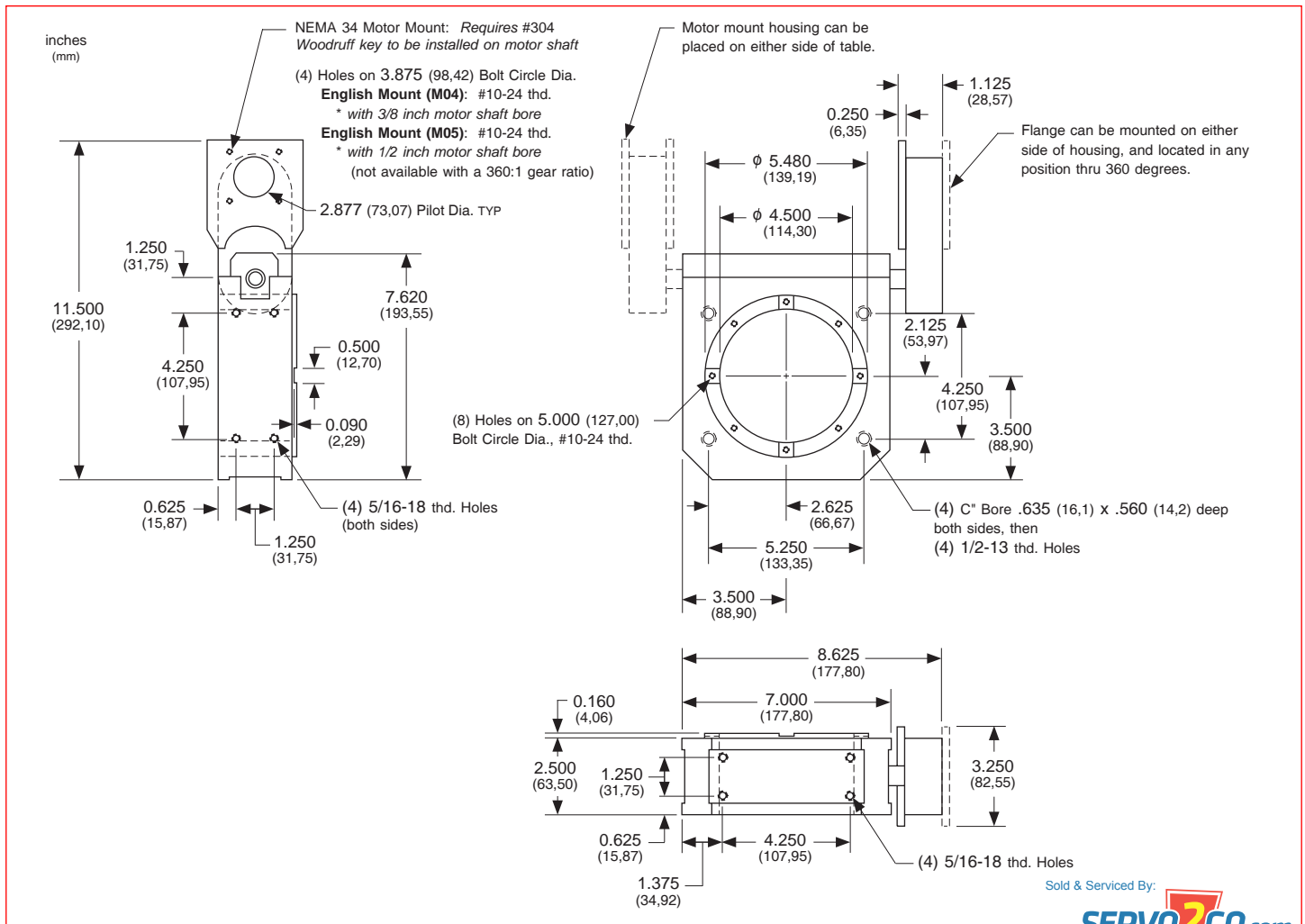

Sold & Serviced By: **SERVO2GO.com**

Toll Free Phone: 877-378-0240  
 Toll Free Fax: 877-378-0249  
 sales@servo2go.com  
 www.servo2go.com

Specifications subject to change without notice

## Motor Couplings

*LINTECH* provides two different types of couplings that can be used to mount a motor to a 300 series positioning table. These couplings compensate for misalignment between the motor shaft & worm gear drive shaft extension. This provides for trouble-free operation as long as certain precautions are taken. The connected motor output torque should never exceed the coupling maximum torque capacity. Larger capacity couplings may be required for applications having high accelerations, large back driving loads, high torque output motors, or servo motors.

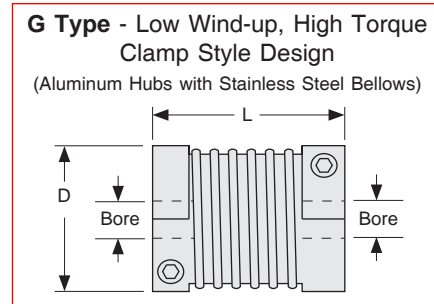
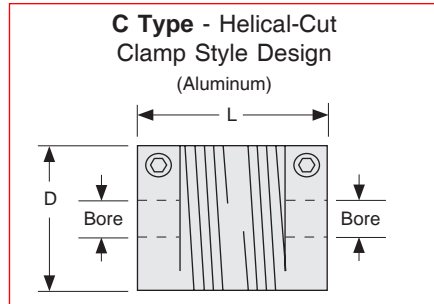

Model (1) Number	D inches (mm)	L inches (mm)	Bore Diameters				Weight ounces (grams)	Inertia oz-in <sup>2</sup> (g-cm <sup>2</sup> )	Wind-up arc-sec/oz-in (deg/N-m)	Max Torque oz-in (N-m)
			Table	Motor	Minimum (in) (mm)	Maximum (in) (mm)				
<b>C075-187-aaa</b>	0.75 (19,1)	1.00 (25,4)	<b>187</b>	<b>aaa</b>	.187 5	.250 8	0.8 (23)	.06 (10)	45.0 (1,8)	200 (1,4)
<b>G075-187-aaa</b>	0.79 (20,0)	1.02 (26,0)	<b>187</b>	<b>aaa</b>	.187 5	.375 10	0.8 (23)	.06 (10)	2.0 (0,08)	300 (2,1)
<b>G075-250-aaa</b> <sup>(2)</sup>	0.79 (20,0)	1.02 (26,0)	<b>250</b>	<b>aaa</b>	.187 5	.375 10	0.8 (23)	.06 (10)	2.0 (0,08)	300 (2,1)
Possible values for <b>aaa</b>	187 = .187 inch 250 = .250 inch 375 = .375 inch		005 = 5 mm 006 = 6 mm 008 = 8 mm 010 = 10 mm							

### Footnotes:

- (1) 0.85 inch (21,6 mm) is the largest diameter coupling allowed to be used with the 300 series because of the internal motor mount clearance.
- (2) This coupling option can not be used with any NEMA 23 motor mount. Also, it can not be used with the optional NEMA 34 motor mount for the 6 and 10 inch table top models. It can only be used with the optional NEMA 34 motor mount for the 8 and 12 inch table top models.

### Coupling Part Numbers

<b>C001</b>	C075-187-250	<b>C375</b>	G075-187-250
<b>C002</b>	C075-187-005	<b>C376</b>	G075-187-375
<b>C003</b>	C075-187-006	<b>C377</b>	G075-187-005
<b>C004</b>	C075-187-008	<b>C378</b>	G075-187-006
		<b>C379</b>	G075-187-008
		<b>C380</b>	G075-187-010
		<b>C381</b>	G075-250-250
		<b>C382</b>	G075-250-375
		<b>C383</b>	G075-250-005
		<b>C384</b>	G075-250-006
		<b>C385</b>	G075-250-008
		<b>C386</b>	G075-250-010

Sold &amp; Serviced By:

Toll Free Phone: 877-378-0240

Toll Free Fax: 877-378-0249

sales@servo2go.com

www.servo2go.com



NEMA 34 Motor Mount

The 300 series NEMA 34 motor adapter bracket is an aluminum flange that mounts to the front of the NEMA 23 motor mount for the 6 & 10 inch table top diameters. For the 8 & 12 inch table top diameters, *LINTECH* provides a motor mount extension which allows for a NEMA 34 motor mount that will NOT contact the rotating table top. The bracket can be ordered in either an English, or Metric motor mount. *LINTECH* can provide adapter brackets for any step motor, or servo motor, that has other mounting requirements.

Material  
Aluminum

Weight  
.500 lbs  
(0,227 kg)

(M04 & M05)

inches  
(mm)

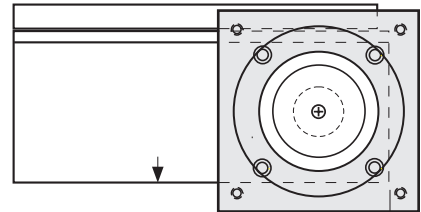
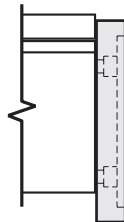
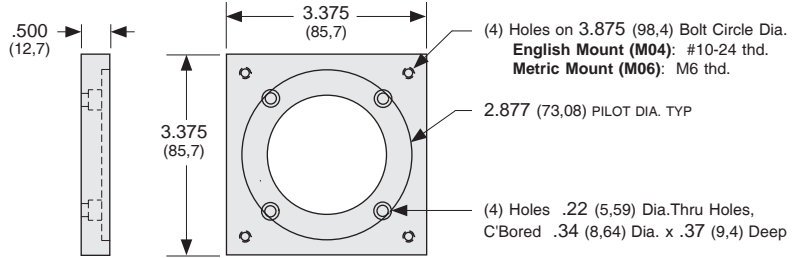

6 inch  
Table Top

.498 (12,65) .540 (13,72)

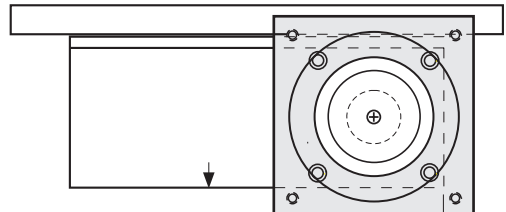
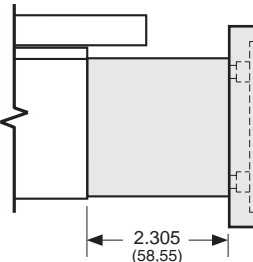

8 inch  
Table Top

.498 (12,65) .540 (13,72)

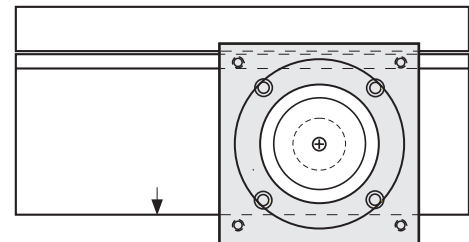
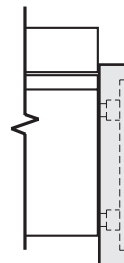

10 inch  
Table Top

.498 (12,65)

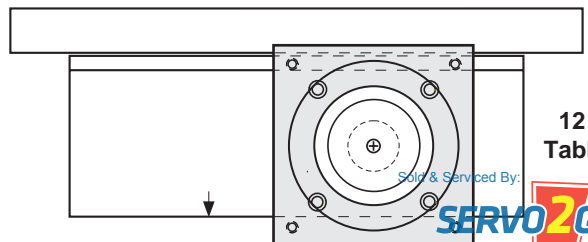
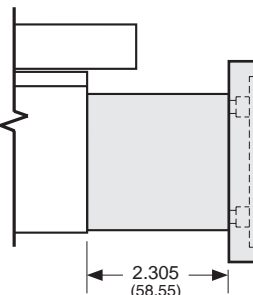

12 inch  
Table Top

.498 (12,65)



Toll Free Phone: 877-378-0240  
Toll Free Fax: 877-378-0249  
sales@servo2go.com  
www.servo2go.com

Specifications subject to change without notice

## Home Switch

**300 Series**

The home switch option on the 300 series is mounted internally to the positioning table and is wired to a connector which is located on the side of the base. A mating connector with a 10 foot (3 m) shielded cable is provided with either the reed, or hall, home switch option.

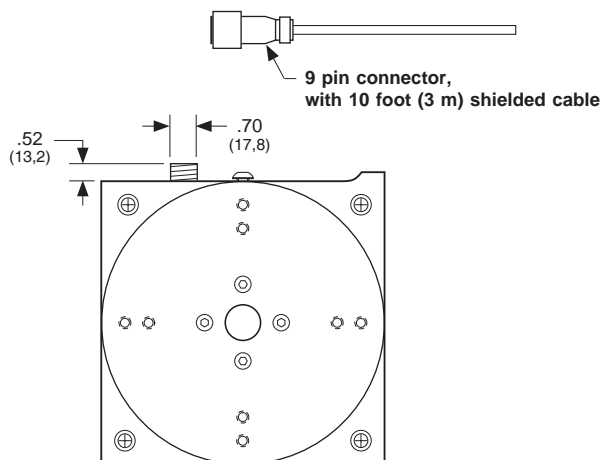
**400 Series**

The home switch option on the 400 series is mounted externally to the positioning table and is pre-wired with a 10 foot (3 m) shielded cable.

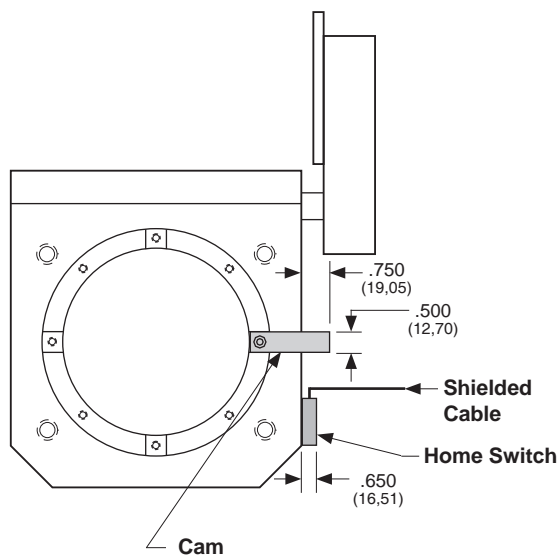
**Mechanical Switches**

Repeatability	: +/- 10 arc-sec
Electrical	: 5 amps @ 125 VAC 1 amp @ 85 VDC
Activation Style	: mechanical cam
Activation Area	: 0.5 inches (12.7 mm) of travel
Temperature Range	: - 25° C to + 85° C
Environment	: non wash down
Individual Switch Wiring	: none

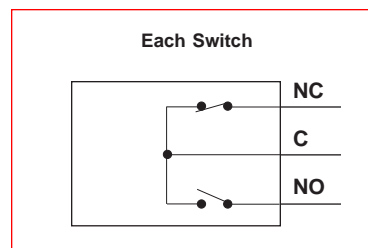

Standard *LINTECH* Wiring : from table,  
(provided when switch option is ordered with any table) 10 foot (3 m) shielded cable, 6 conductor, 24 AWG, unterminated leads

**400 Series**

Wire Color	Description
Brown	HOME
Green	HOME Common
Silver	Shield

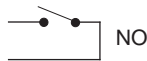

Sold &amp; Serviced By:

Toll Free Phone: 877-378-0249  
Toll Free Fax: 877-378-0249  
sales@servo2go.com  
www.servo2go.com

## Home Switch

**Non-Contact Reed Switches**

Repeatability	: +/- 100 arc-sec
Electrical	: 1.0 amps @ 125 VAC 0.5 amps @ 100 VDC
Activation Style	: magnetic
Activation Area	: 0.30 inches (7,62 mm) of travel
Temperature Range	: - 10° C to + 60° C
Environment	: non wash down
Individual Switch Wiring	: 12 inch (305 mm) leads

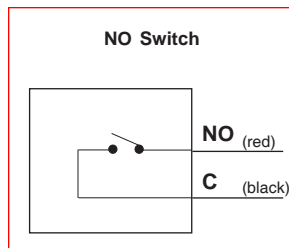

Standard *LINTECH* Wiring : from table,  
(provided when switch option is ordered with any table) 10 foot (3 m) shielded cable, 6 conductor, 24 AWG, unterminated leads

**300 Series**

Pin #	Wire Color	Description
7	Brown	HOME (red)
8	Green	HOME Common (black)
3	Silver	Shield

**Non-Contact Hall Effect Switches**

Repeatability	: +/- 10 arc-sec
Electrical	: 5 - 24 VDC 15 mA - power input 25 mA max - signal
Actuation Style	: magnetic
Activation Area	: 0.32 inches (8,13 mm) of travel
Temperature Range	: - 10° C to + 60° C
Environment	: wash down
Individual Switch Wiring	: 12 inch (305 mm) leads

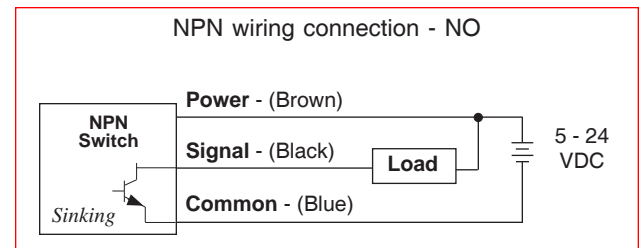

Standard *LINTECH* Wiring : from table,  
(provided when switch option is ordered with any table) 10 foot (3 m) shielded cable; 9 conductor, 24 AWG, unterminated leads

**300 Series**

Pin #	Wire Color	Description
5	Orange	Home Power (brown)
7	Yellow	Home (black)
8	Grey	Home Common (blue)
3	Silver	Shield

NO - Normally Open

Sold & Serviced By:

**SERVO2GO.com**

Toll Free Phone: 877-378-0240

Toll Free Fax: 877-378-0249

sales@servo2go.com

www.servo2go.com

Specifications subject to change without notice