

Cup Type Component Sets & Housed Units

CSF & CSG Series
Component Sets
Housed Units



Total Motion Control

Harmonic Drive™ gear

Precision Gearing and Motion Control

ABOUT Harmonic Drive™	
Ordering Information	4
Strain Wave Gearing Mechanism	5
System Components	5
Driving Configurations	6
Application Examples	7
Rating Table	10
Technical Terms, Strength & Life	12
Technical Terms, Life	13
Selection Procedure	14
Selection Example	15
COMPONENT TYPE CSF, CSG-2A	
External Dimension & Shape	16
External Dimension table	18
Grease Lubrication	20
Oil Lubrication	22
Recommended Tolerances for Assembly	24
Wave Generator Bore Modifications	25
Assembly of the Flexspline, Installation	26
Assembly of the Flexspline, Bolts and Screws	27
Assembly of Circular Spline, Bolts	28
Assembly Procedure	29
UNIT TYPES CSF, CSG-2UH	
External Dimensions of Housed Unit	30
Specifications for Cross Roller Bearing	31
Output Bearing Life	32
Recommended Tolerances for Assembly	34
ENGINEERING DATA	
Efficiency of Component Set	36
Efficiency of Housed Unit	38
No Load Running Torque	42
Starting Torque and Backdriving Torque	46
Positioning Accuracy	47
Torsional Stiffness	48
Hysteresis Loss	49
Backlash from Oldham Coupling	49
Surface Treatment	49

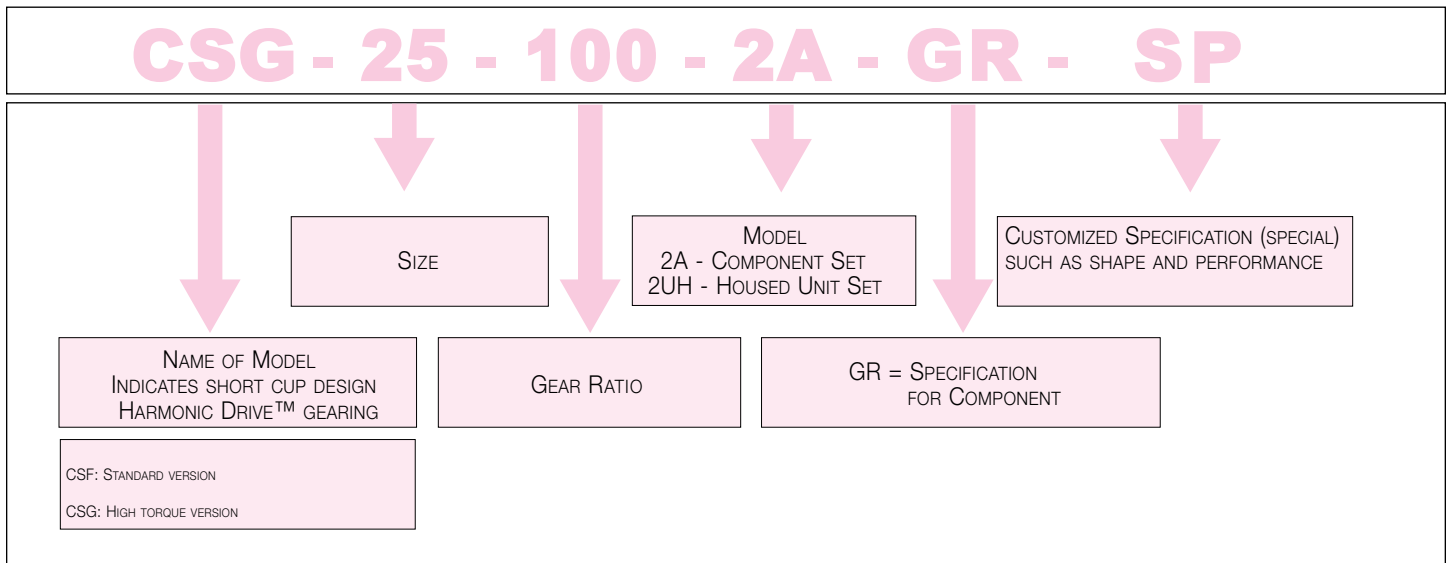

Harmonic Drive™ Gear Revolution

Harmonic Drive™ precision gear continues to evolve by improving performance and functionality.

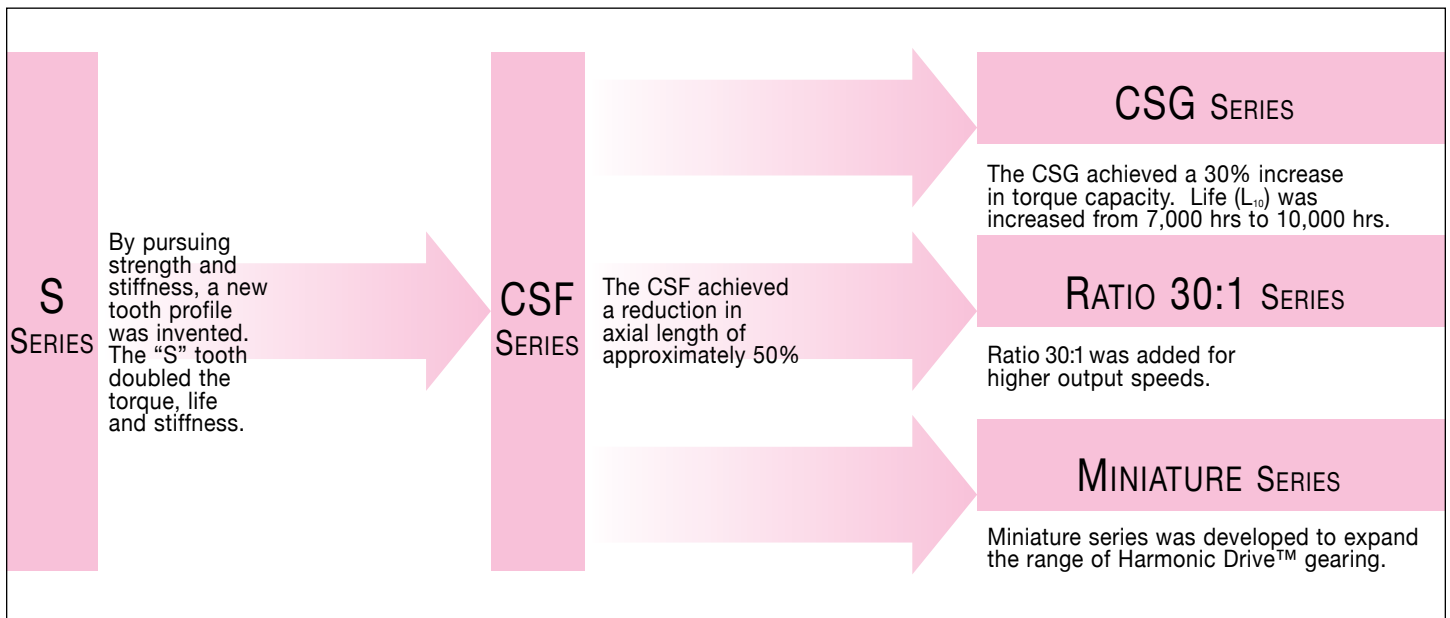

Tooth Profiles

The Harmonic Drive™ CSF/CSG component sets and housed units presented in this catalog incorporate the “S” gear tooth profile. This patented tooth profile provides a significant improvement in gear operating characteristics and performance.

The new “S” tooth profile significantly increases the region of tooth engagement. For the traditional tooth profile 15% of the total number of teeth are in contact, while for the new profile up to 30% of the teeth are in contact. The increased number of teeth in engagement results in a 100% increase in torsional stiffness in the low & mid torque ranges.

The new tooth profile also features an enlarged tooth root radius, which results in a higher allowable stress and a corresponding increase in torque capacity. Furthermore, the enlarged region of tooth engagement leads to a more even loading of the Wave Generator bearing, resulting in more than double the life expectancy for the gear.

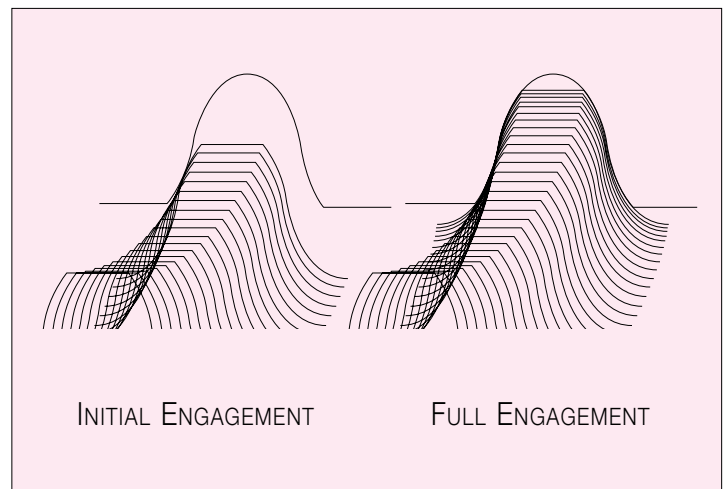

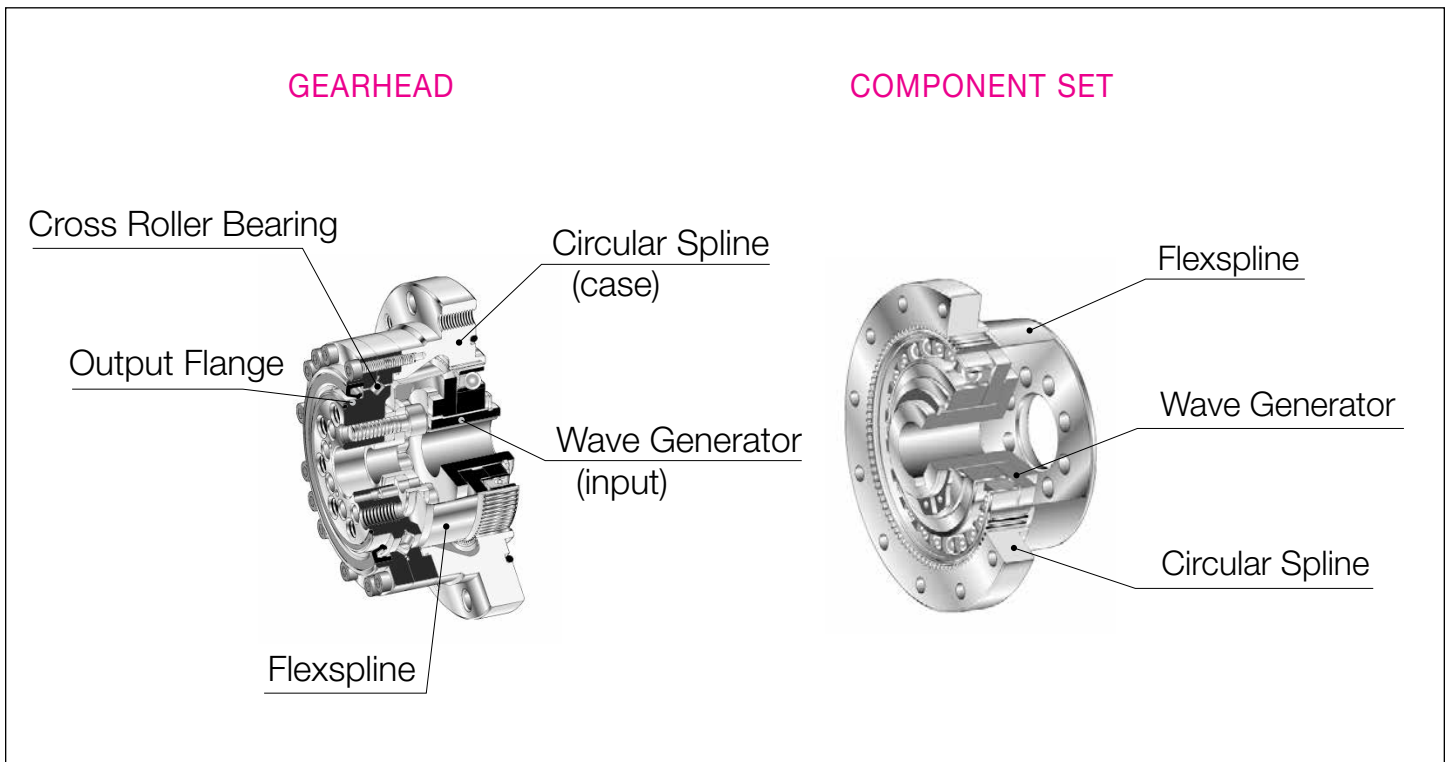

System Components

The Flexspline is a non-rigid, thin cylindrical cup with external teeth on a slightly smaller pitch diameter than the Circular Spline. It fits over and is held in an elliptical shape by the Wave Generator.

The WAVE GENERATOR is a thin raced ball bearing fitted onto an elliptical plug serving as a high efficiency torque converter.

The CIRCULAR SPLINE is a rigid ring with internal teeth, engaging the teeth of the Flexspline across the major axis of the Wave Generator.

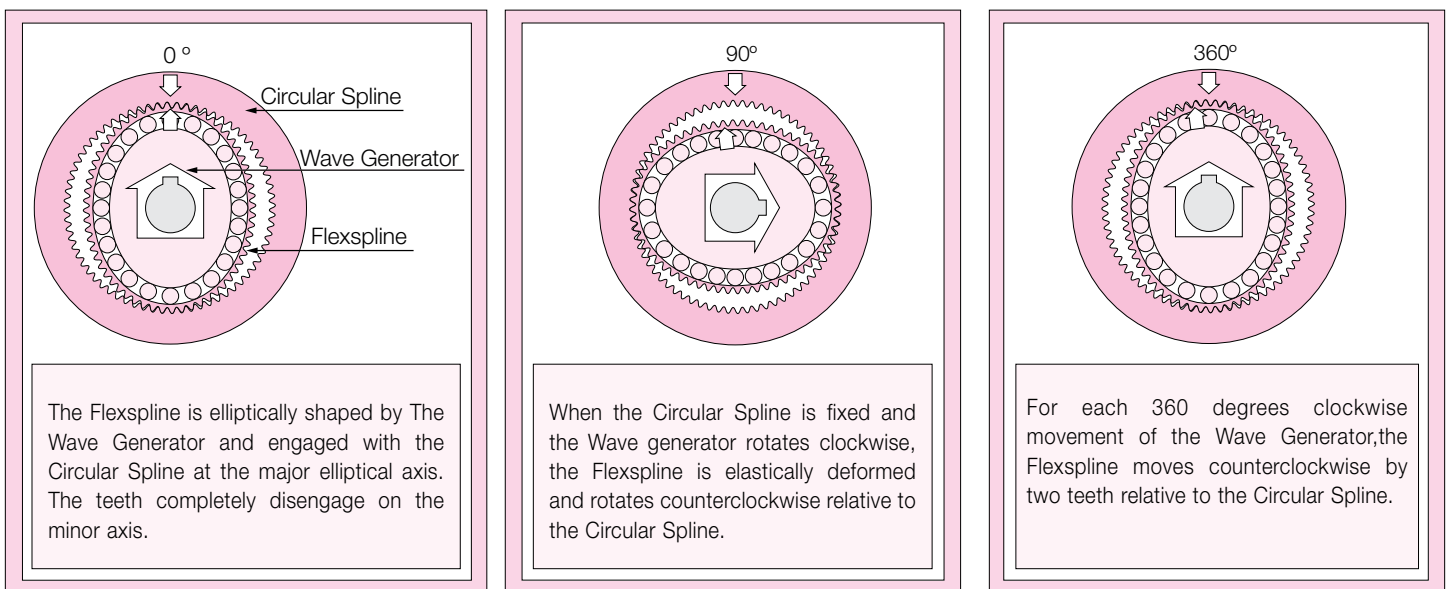

Driving Configurations

Driving Configurations

A variety of different driving configurations are possible, as shown below.

The reduction ratio given in the tables on page 10 and 11 correspond to arrangement 1, in which the Wave Generator acts as the input element, the Circular Spine is fixed and the Flexspine acts as the output element.

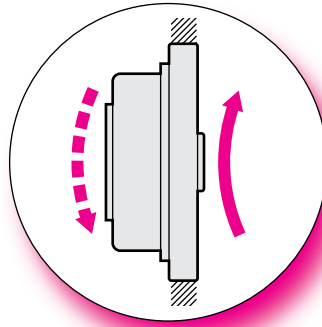

1. Reduction Gearing
 CS Fixed
 WG Input
 FS Output

$$\text{Ratio} = -\frac{R}{1} \quad [\text{Equation 1}]$$

Input and output in opposite direction.

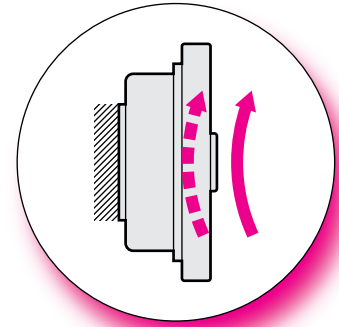

2. Reduction Gearing
 FS Fixed
 WG Input
 CS Output

$$\text{Ratio} = \frac{R+1}{1} \quad [\text{Equation 2}]$$

Input and output in same direction.

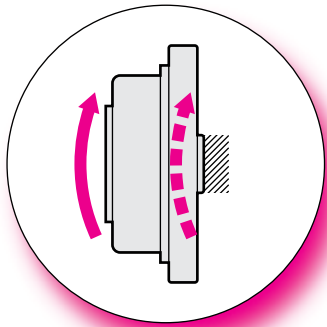

3. Reduction Gearing
 WG Fixed
 FS Input
 CS Output

$$\text{Ratio} = \frac{R+1}{R} \quad [\text{Equation 3}]$$

Input and output in same direction.

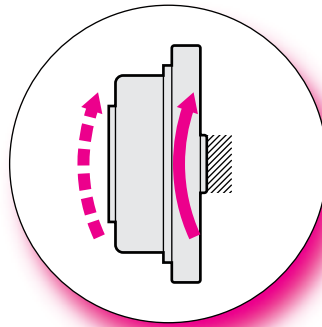

4. Speed Increaser Gearing
 WG Fixed
 CS Input
 FS Output

$$\text{Ratio} = \frac{R}{R+1} \quad [\text{Equation 4}]$$

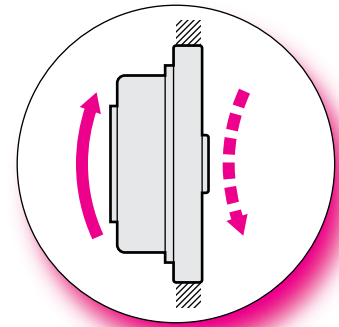

5. Speed Increaser Gearing
 CS Fixed
 FS Input
 WG Output

$$\text{Ratio} = -\frac{1}{R} \quad [\text{Equation 5}]$$

Input and output in opposite direction.

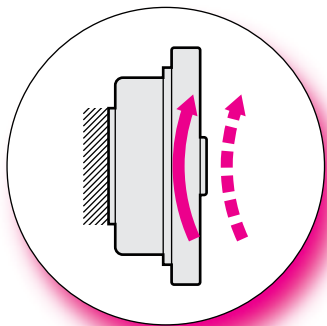

$$\text{Ratio} = \frac{1}{R+1} \quad [\text{Equation 6}]$$

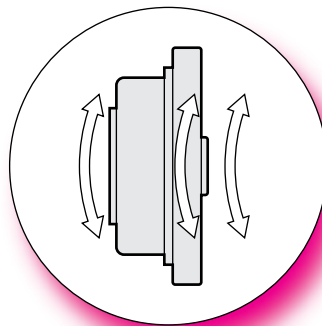

7. Differential Gearing
 WG Control Input
 CS Main Drive-Input
 FS Main Drive-Output

Numerous differential functions can be obtained by combinations of the speed and rotational direction of the three basic elements.

The CSF Cup-Style Component Set achieves higher performance than the Pancake Style Component Set in the same package size.

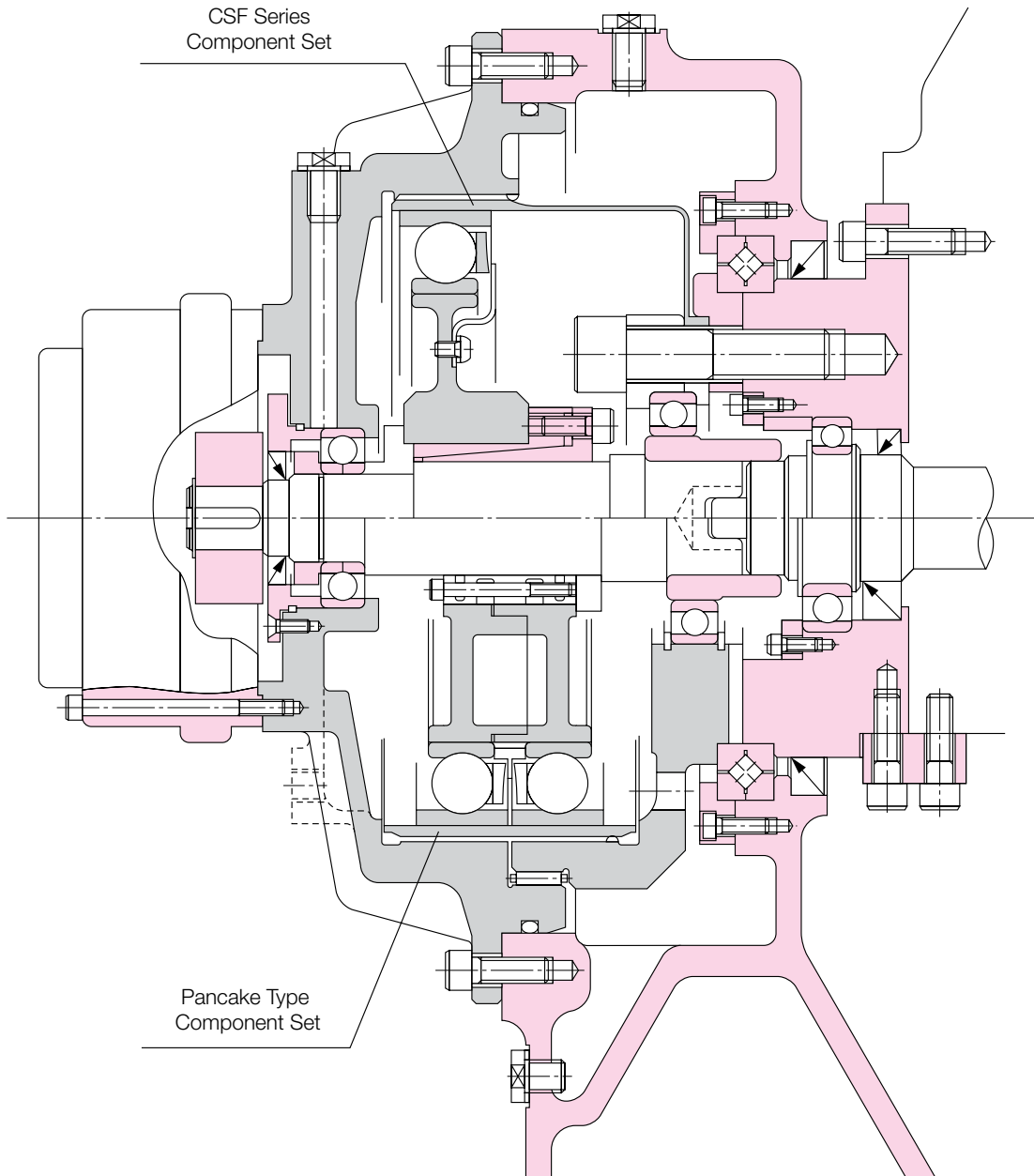

Tool Changer

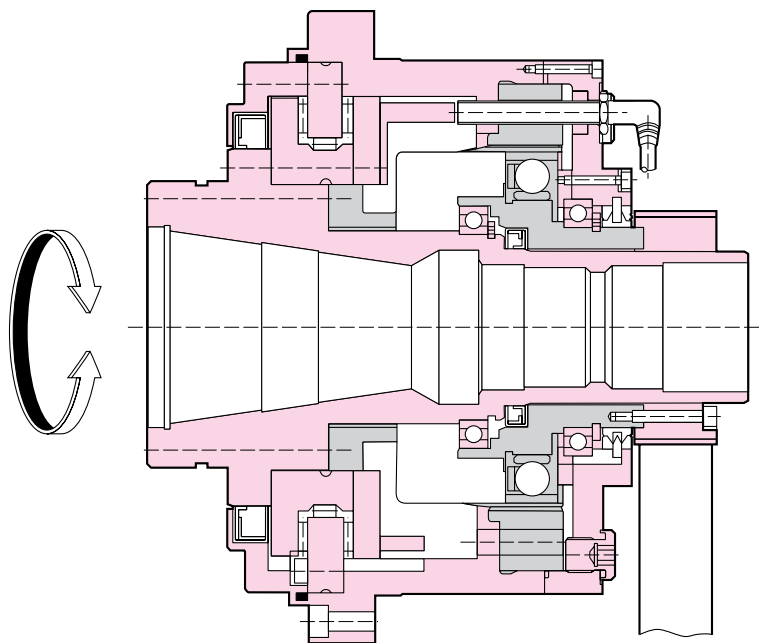

Multi-joint Robot

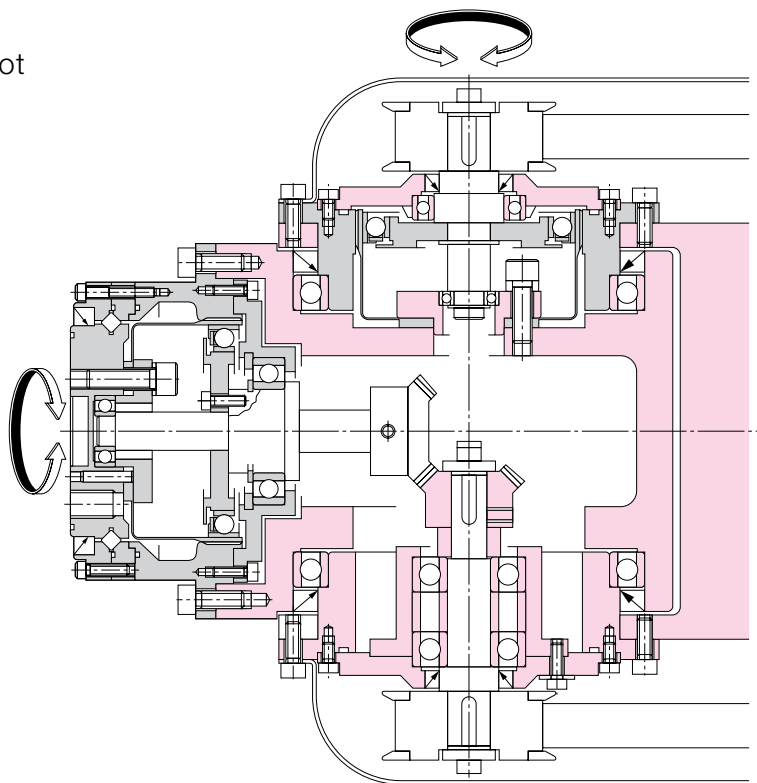

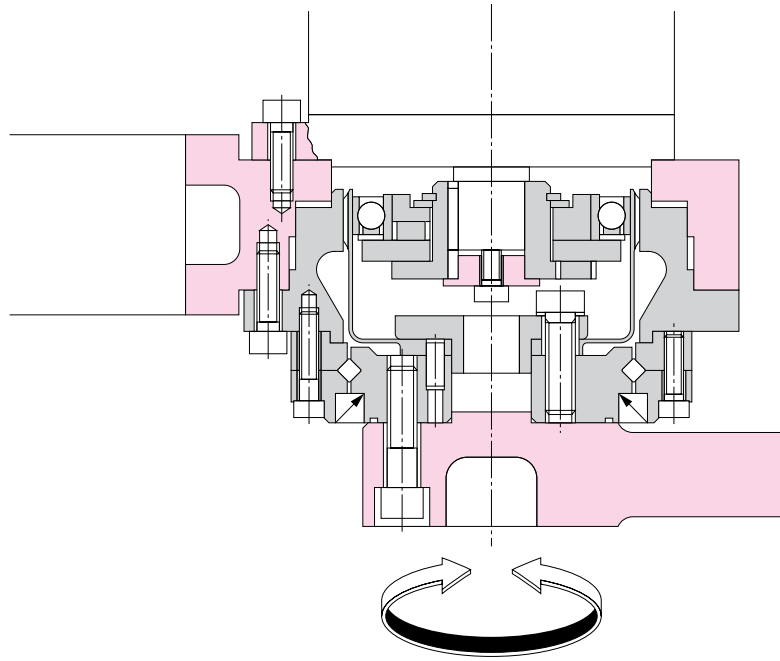

Housed Unit -
Direct Connection
to Servo Motor

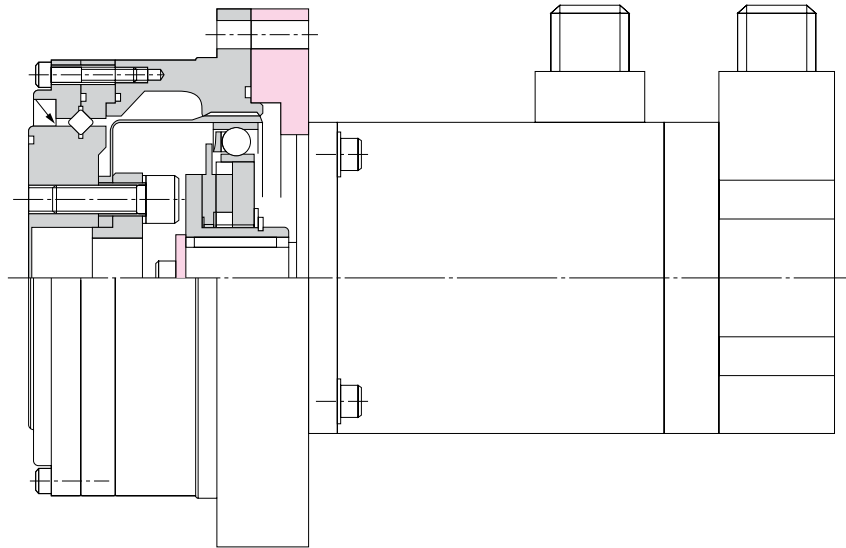

Housed Unit -
Input Shaft Option

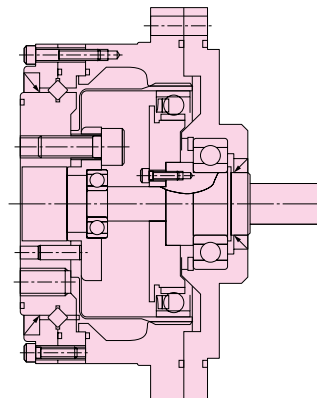

CSF Rating Table

Table 1

Size	Ratio	Rated Torque at 2000 T_r rpm		Limit for Repeated Peak Torque		Limit for Average Torque		Limit for Momentary Peak Torque		Maximum Input Speed		Limit for Average Input Speed		Moment of Inertia	
		Nm	in-lb	Nm	in-lb	Nm	in-lb	Nm	in-lb	rpm		rpm		$\times 10^{-4} \text{kg}\cdot\text{m}^2 \times 10^{-5} \text{kgf}\cdot\text{m}\cdot\text{s}^2$	
										Oil	Grease	Oil	Grease		
8	30	0.9	8	1.8	16	1.4-	12	3.3	29	14000	8500	6500	3500	0.003	0.0031
	50	1.8	16	3.3	29	2.3-	20	6.6	58						
	100	2.4	18	4.8	42	3.3-	29	9.0	80						
11	30	2.2	19	4.5	40	3.4-	30	8.5	75	14000	8500	6500	3500	0.012	0.012
	50	3.5	31	8.3	73	5.5-	49	17	150						
	100	5.0	44	11	97	8.9-	79	25	221						
14	30	4.0	35	9.0	80	6.8	60	17	150	14000	8500	6500	3500	0.033	0.034
	50	5.4	48	18	159	6.9	61	35	310						
	80	7.8	69	23	204	11	97	47	416						
17	100	7.8	69	28	248	11	97	54	478	10000	7300	6500	3500	0.079	0.081
	30	8.8	78	16	142	12	106	30	266						
	50	16	142	34	301	26	230	70	620						
	80	22	195	43	381	27	239	87	770						
	120	24	212	54	478	39	345	108	956						
20	30	15	133	27	239	20	177	50	443	10000	6500	6500	3500	0.193	0.197
	50	25	221	56	496	34	301	98	867						
	80	34	301	74	655	47	411	127	1124						
	100	40	354	82	726	49	434	147	1301						
	120	40	354	87	770	49	434	147	1301						
25	160	40	354	92	814	49	434	147	1301	7500	5600	5600	3500	0.413	0.421
	30	27	239	50	443	38	336	95	841						
	50	39	345	98	868	55	487	186	1646						
	80	63	558	137	1212	87	770	255	2257						
	100	67	593	157	1389	108	956	284	2513						
32	120	67	593	167	1478	108	956	304	2690	7000	4800	4600	3500	1.69	1.72
	160	67	593	176	1558	108	956	314	2779						
	30	54	478	100	885	75	664	200	1770						
	50	76	673	216	1912	108	956	382	3381						
	80	118	1044	304	2690	167	1478	568	5027						
40	100	137	1212	333	2947	216	1912	647	5726	5600	4000	3600	3000	4.50	4.59
	120	137	1212	353	3124	216	1912	686	6071						
	160	137	1212	372	3292	216	1912	686	6071						
	50	137	1212	402	3558	196	1735	686	6071						
	80	206	1823	519	4593	284	2513	980	8673						
45	100	265	2345	568	5027	372	3292	1080	9558	5000	3800	3300	3000	8.68	8.86
	120	294	2602	617	5460	451	3991	1180	10443						
	160	294	2602	647	5726	451	3991	1180	10443						
	50	176	1558	500	4425	265	2345	950	8408						
	80	313	2770	706	6248	390	3452	1270	11240						
50	100	353	3124	755	6682	500	4425	1570	13895	4500	3500	3000	2500	12.5	12.8
	120	402	3558	823	7284	620	5487	1760	15576						
	160	402	3558	882	7806	630	5576	1910	16904						
	50	245	2168	715	6328	350	3098	1430	12656						
	80	372	3292	941	8328	519	4593	1860	16461						
58	100	470	4160	980	8673	666	5894	2060	18231	4000	3000	2700	2200	27.3	27.9
	120	529	4682	1080	9558	813	7195	2060	18231						
	160	529	4682	1180	10443	843	7461	2450	21683						
58	50	353	3124	1020	9027	520	4602	1960	17346	4000	3000	2700	2200	27.3	27.9
	80	549	4859	1480	13098	770	6815	2450	21683						
	100	696	6160	1590	14072	1060	9381	3180	28143						
	120	745	6593	1720	15222	1190	10532	3330	29471						
	160	745	6593	1840	16284	1210	10709	3430	30356						

Table 2

Size	Ratio	Rated Torque at 2000 Tr rpm		Limit for Repeated Peak Torque		Limit for Average Torque		Limit for Momentary Peak Torque		Maximum Input Speed rpm		Limit for Average Input Speed rpm		Moment of Inertia	
		Nm	in-lb	Nm	in-lb	Nm	in-lb	Nm	in-lb	Oil	Grease	Oil	Grease	x10 ⁻⁴ kg·m ²	x10 ⁻⁵ kgf·m·s ²
65	50	490	4337	1420	12567	720	6372	2830	25046	3500	2800	2400	1900	46.8	47.8
	80	745	6593	2110	187	1040	9204	3720	32922						
	100	951	8416	2300	20355	1520	13452	4750	42038						
	120	951	8416	2510	22214	1570	13895	4750	42038						
	160	951	8416	2630	23276	1570	13895	4750	42038						
80	50	872	7717	2440	21594	1260	11151	4870	43100	2900	2300	2200	1500	122	124
	80	1320	11682	3430	30356	1830	16196	6590	58322						
	100	1700	15045	4220	37347	2360	20886	7910	70004						
	120	1990	17612	4590	40622	3130	27701	7910	70004						
	160	1990	17612	4910	43454	3130	27701	7910	70004						
90	50	1180	10443	3530	31241	1720	15222	6660	58941	2700	2000	2100	1300	214	218
	80	1550	13718	3990	35312	2510	22214	7250	64163						
	100	2270	20090	5680	50268	3360	29736	9020	79827						
	120	2570	22745	6160	54516	4300	38055	9800	86730						
	160	2700	23895	6840	60534	4300	38055	11300	100005						
100	50	1580	13983	4450	39383	2280	20178	8900	78765	2500	1800	2000	1200	356	363
	80	2380	21063	6060	53631	3310	29294	11600	102660						
	100	2940	26019	7350	65048	4630	40976	14100	124785						
	120	3180	28143	7960	70446	5720	50622	15300	135405						
	160	3550	31418	9180	81243	5720	50622	15500	137175						

CSG Rating Table

Table 3

Size	Ratio	Rated Torque at 2000 Tr rpm		Limit for Repeated Peak Torque		Limit for Average Torque		Limit for Momentary Peak Torque		Maximum Input Speed rpm		Limit for Average Input Speed rpm		Moment of Inertia	
		Nm	in-lb	Nm	in-lb	Nm	in-lb	Nm	in-lb	Oil	Grease	Oil	Grease	x10 ⁻⁴ kg·m ²	x10 ⁻⁵ kgf·m·s ²
14	50	7.0	62	23	204	9	80	46	407	14000	8500	6500	3500	0.033	0.0034
	80	10	89	30	266	14	124	61	540						
	100	10	89	36	319	14	124	70	620						
17	50	21	186	44	390	34	301	91	805	10000	7300	6500	3500	0.079	0.081
	80	29	257	56	496	35	310	113	1000						
	100	31	274	70	620	51	451	143	1266						
	120	31	274	70	620	51	451	112	991						
20	50	33	292	73	646	44	389	127	1124	10000	6500	6500	3500	0.193	0.197
	80	44	389	96	850	61	540	165	1460						
	100	52	460	107	947	64	566	191	1690						
	120	52	460	113	1000	64	566	191	1690						
	160	52	460	120	1062	64	566	191	1690						
25	50	51	451	127	1124	72	637	242	2142	7500	5600	5600	3500	0.413	0.421
	80	82	726	178	1575	113	1000	332	2938						
	100	87	770	204	1805	140	1239	369	3266						
	120	87	770	217	1920	140	1239	395	3496						
	160	87	770	229	2027	140	1239	408	3611						
32	50	99	876	281	2487	140	1239	497	4399	7000	4800	4600	3500	1.69	1.72
	80	153	1354	395	3496	217	1920	738	6531						
	100	178	1575	433	3832	281	2487	841	7443						
	120	178	1575	459	4062	281	2487	892	7894						
	160	178	1575	484	4283	281	2487	892	7894						
40	50	178	1575	523	4629	255	2257	892	7894	5600	4000	3600	5000	4.50	4.59
	80	268	2372	675	5974	369	3266	1270	11240						
	100	345	3053	738	6531	484	4283	1400	12390						
	120	382	3381	802	7098	586	5186	1530	13541						
	160	382	3381	841	7443	586	5186	1530	13541						

CSG Rating Table

Table 4

Size	Ratio	Rated Torque at 2000 Tr rpm		Limit for Repeated Peak Torque		Limit for Average Torque		Limit for Momentary Peak Torque		Maximum Input Speed rpm		Limit for Average Input Speed rpm		Moment of Inertia	
		Nm	in-lb	Nm	in-lb	Nm	in-lb	Nm	in-lb	Oil	Grease	Oil	Grease	$\times 10^{-4} \text{kg}\cdot\text{m}^2$	$\times 10^{-5} \text{kgf}\cdot\text{m}\cdot\text{s}^2$
45	50	229	2,027	650	5,753	345	3,053	1,235	10,930	5,000	3,800	3,300	3,000	8.68	8.86
	80	407	3,602	918	8,124	507	4,487	1,651	14,611						
	100	459	4,062	982	8,691	650	5,753	2,041	18,063						
	120	523	4,629	1,070	9,470	806	7,133	2,288	20,249						
	160	523	4,629	1,147	10,151	819	7,248	2,483	21,975						
50	80	484	4,283	1,223	10,824	675	5,974	2,418	21,399	4,500	3,500	3,000	2,500	12.5	12.8
	100	611	5,407	1,274	11,275	866	7,664	2,678	23,700						
	120	688	6,089	1,404	12,425	1,057	9,354	2,678	23,700						
	160	688	6,089	1,534	13,576	1,096	9,700	3,185	28,187						
58	80	714	6,319	1,924	17,027	1,001	8,859	3,185	28,187	4,000	3,000	2,700	2,200	27.3	27.9
	100	905	8,009	2,067	18,293	1,378	12,195	4,134	36,586						
	120	969	8,576	2,236	19,789	1,547	13,691	4,329	38,312						
	160	969	8,576	2,392	21,169	1,573	13,921	4,459	39,462						
65	80	969	8,576	2,743	24,276	1,352	11,965	4,836	42,799	3,500	2,800	2,400	1,900	46.8	47.8
	100	1,236	10,939	2,990	26,462	1,976	17,488	6,175	54,649						
	120	1,236	10,939	3,263	28,878	2,041	18,063	6,175	54,649						
	160	1,236	10,939	3,419	30,258	2,041	18,063	6,175	54,649						

Definition of Ratings

Rated Torque (Tr)

Rated torque indicates allowable continuous load torque at 2000 rpm input speed.

Limit for Repeated Peak Torque (refer to figure 1)

During acceleration or deceleration the Harmonic Drive™ gear experiences a peak torque as a result of the moment of inertia of the output load.

Limit for Average Torque

In cases where load torque and input speed vary, it is necessary to calculate an average value of load torque. The table indicates the limit for average torque. The average torque calculated must not exceed this limit.

Limit for Momentary Peak Torque (refer to figure 1)

The gear may be subjected to momentary peak torques in the event of a collision or emergency stop. The magnitude and frequency of occurrence of such peak torques must be kept to a minimum and they should, under no circumstance, occur during normal operating cycle. The allowable number of occurrences of the momentary peak torque may be calculated by using equation 7 on page 13. Also see section “strength and life”.

Figure 1

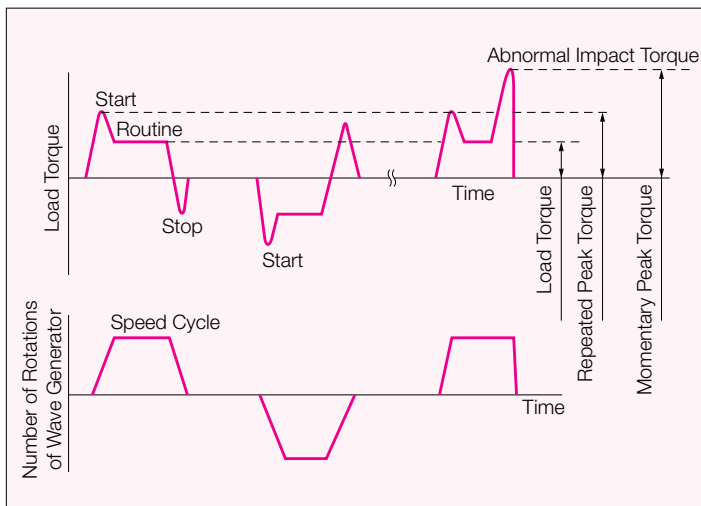

Maximum Input Speed, Limit for average input speed

Do not exceed the allowable rating.

Moment of Inertia

The rating indicates the moment of inertia reflected to the wave generator (gear input).

Strength and Life

The non-rigid Flexspline is subjected to repeated deflections, and its strength determines the torque capacity of the Harmonic Drive™ gear. The values given for Rated Torque at Rated Speed and for the allowable Repeated Peak Torque are based on an infinite fatigue life for the Flexspline.

The torque that occurs during a collision must be below the momentary peak torque (impact torque). The maximum number of occurrences is given by the equation below.

[Equation 7]

$$N = \frac{1.0 \times 10^4}{2 \times \frac{n}{60} \times t}$$

n: Input speed before collision (r/min)
t: Time interval during collision (sec)

Please note:

If this number is exceeded, the Flexspline may experience a fatigue failure.

Ratcheting phenomenon

When excessive torque is applied while the gear is in motion, the teeth between the Circular Spline and Flexspline may not engage properly. This phenomenon is called ratcheting and the torque at which this occurs is called ratcheting torque. Ratcheting may cause the Flexspline to become non-concentric with the Circular Spline. (See figure 1 & 2 on page 13) Operating in this condition may result in shortened life and a Flexspline fatigue failure.

Figure 2

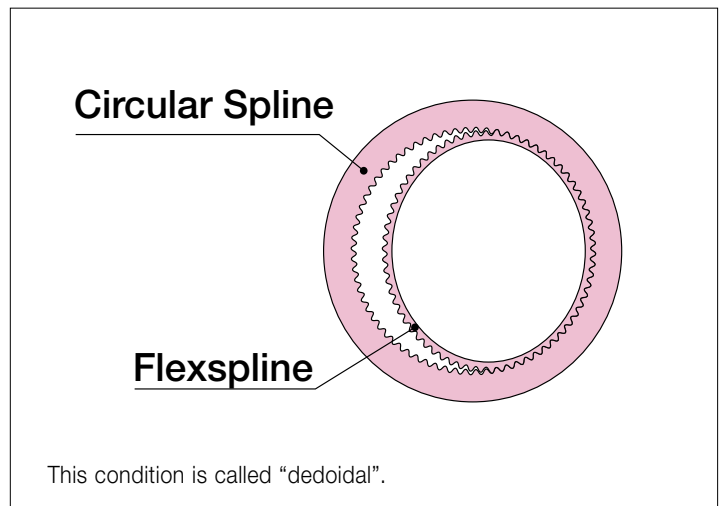

Note!

When ratcheting occurs, the teeth mesh abnormally as shown above. Vibration and Flexspline damage may occur.

Once ratcheting occurs, the teeth wear excessively and the ratcheting torque may be lowered.

Technical Terms

CSF Ratcheting Torque Table 4							Nm
Size	Ratio						
	30	50	80	100	120	160	
8	11	12	-	14	-	-	
11	29	34	-	43	-	-	
14	59	88	110	84	-	-	
17	100	150	200	160	120	-	
20	170	220	350	260	240	220	
25	340	450	680	500	470	450	
32	720	980	1400	1000	980	980	
40	-	1800	2800	2100	1900	1800	
45	-	2700	3900	3100	2800	2600	
50	-	3700	5400	4100	3800	3600	
58	-	5800	8200	6400	5800	5600	
65	-	7800	11000	9400	8300	8000	
80	-	14000	22000	16000	15000	14000	
90	-	20000	30000	23000	21000	20000	
100	-	29000	44000	33000	30000	28000	

Table 5		Nm
CSF Buckling Torque	All Ratio	
Size		
8	35	
11	90	
14	190	
17	330	
20	560	
25	1000	
32	2200	
40	4300	
45	5800	
50	8000	
58	12000	
65	17000	
80	31000	
90	45000	
100	58000	

CSG Ratcheting Torque Table 6							Nm
Size	Ratio						
	50	80	100	120	160		
14	110	140	100	-	-		
17	190	260	200	150	-		
20	280	450	330	310	280		
25	580	880	650	610	580		
32	1200	1800	1300	1200	1200		
40	2300	3600	2700	2400	2300		

Table 7		Nm
CSG Buckling Torque	All Ratio	
Size		
14	260	
17	500	
20	800	
25	1700	
32	3500	
40	6700	

The Life of a Wave Generator

The normal life of a gear is determined by the life of the wave generator bearing. The life may be calculated by using the input speed and the output load torque.

Rated Lifetime L_n : ($n = 10$ or 50)

L_{10}	<u>CSF : 7,000</u>	<u>CSG : 10,000</u>
L_{50}	<u>CSF : 35,000</u>	<u>CSG : 50,000</u>

Equation for the expected life of the wave generator under normal operating conditions is given by the equation below.

[Equation 8]

$$L_h = L_n \cdot \left(\frac{Tr}{T_{av}} \right)^3 \cdot \left(\frac{Nr}{N_{av}} \right)$$

L_h : Expected Life, hours

L_n : Rated Lifetime at L_{10} or L_{50}

Tr : Rated Torque (Tables 1, 2, 3)

Nr : Rated input speed (2000 rpm)

T_{av} : Average load torque on output side (page 14)

N_{av} : Average input speed (page 14)

Relative Torque Rating

The chart below shows the various torque specifications relative to rated torque. Rated Torque has been normalized to 1 for comparison.

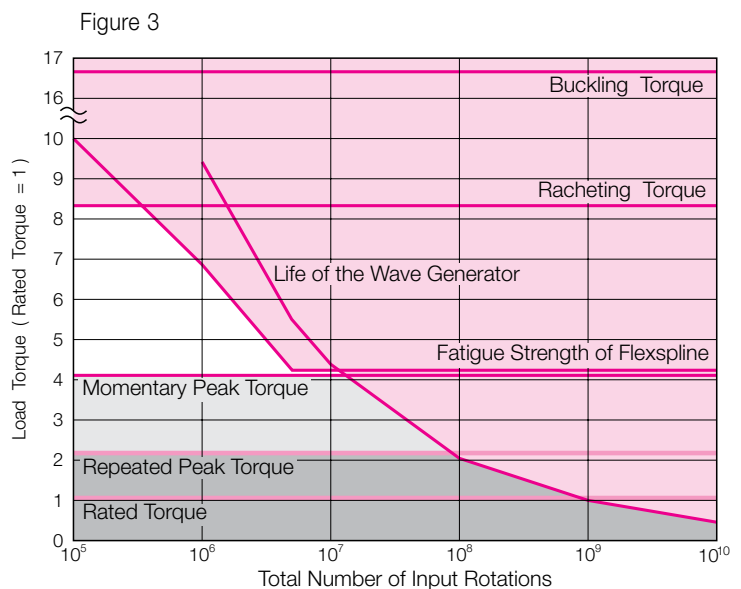

Size Selection

Generally, the operating conditions consist of fluctuating torques and output speeds. Also, an unexpected impact output torque must be considered.

The proper size can be determined by converting fluctuating load torque into average load torque and equivalent load torque. This procedure involves selecting the size based on load torque for component sets.

This procedure does not consider the life of the output bearing for housed units. Determining the life of the output bearing for various axial, radial, and moment loads is outlined on page 31.

Figure 4

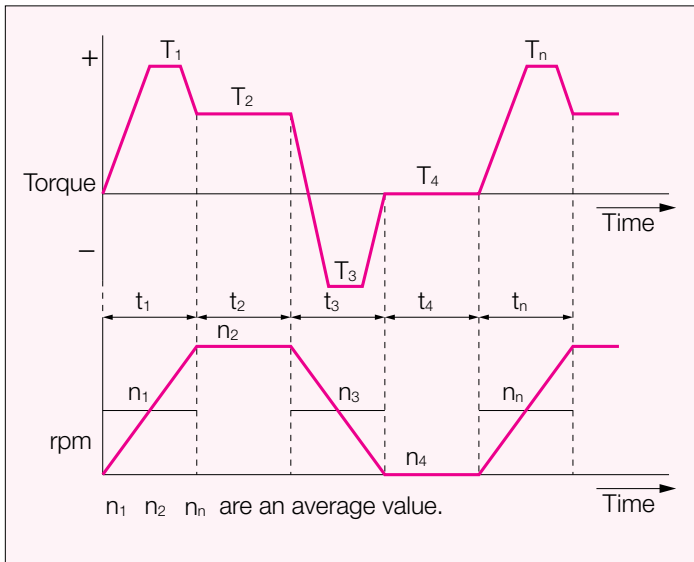

<u>Parameters</u>	
Load Torque	T_n (Nm)
Time	t_n (sec)
Output Speed	n_n (rpm)
<u>Normal Operating Pattern</u>	
Acceleration	T_1, t_1, n_1
Regular Operation	T_2, t_2, n_2
Deceleration	T_3, t_3, n_3
Dwell	T_4, t_4, n_4
<u>Maximum RPM</u>	
Max output speed	n_o maximum
Max input speed	n_i maximum
<u>Impact Torque</u>	
	T_s, t_s, n_s
<u>Ratings</u>	
Rated Torque	T_r
Rated Speed	$nr = 2000$ rpm

Flow Chart for selecting a size

Please use the flowchart shown below for selecting a size. Operating conditions must not exceed the performance ratings as described on page 12.

Calculation of the average output torque

$$T_{av} = \sqrt[3]{\frac{n_1 \cdot t_1 \cdot |T_1|^3 + n_2 \cdot t_2 \cdot |T_2|^3 + \dots + n_n \cdot t_n \cdot |T_n|^3}{n_1 \cdot t_1 + n_2 \cdot t_2 + \dots + n_n \cdot t_n}}$$

Selection of tentative size under the condition shown below.

Average Output Speed

$$N_{av} = \frac{n_1 t_1 + n_2 t_2 + \dots + n_n t_n}{t_1 + t_2 + \dots + t_n}$$

Determine Gear Ratio

$$\frac{n_i \text{ max}}{n_o \text{ max}} \leq R$$

n_i max may be limited by the motor.

Calculation of the average input speed

$$n_i \text{ av} = n_o \text{ av} \cdot R$$

Calculation of maximum input speed

$$n_i \text{ max} = n_o \text{ max} \cdot R$$

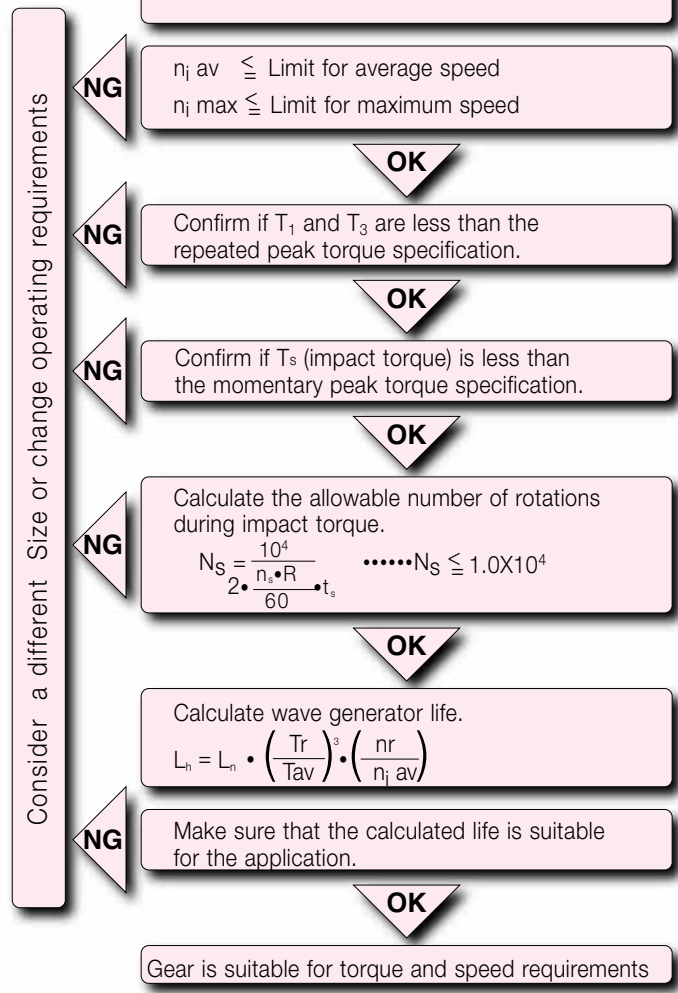

Also consider output bearing, environment, etc.

Selection Example

Values of an each Load Torque Pattern

Load Torque	T_n (Nm)
Time	t_n (sec)
Output Speed	n_n (rpm)

no max = 14 rpm
ni max = 1800 rpm

Normal Operating Pattern

Acceleration	$T_1 = 400$ Nm,	$t_1 = 0.3$ sec,	$n_1 = 7$ rpm
Regular Operation Stop	$T_2 = 320$ Nm,	$t_2 = 3$ sec,	$n_2 = 14$ rpm
Deceleration	$T_3 = 200$ Nm,	$t_3 = 0.4$ sec,	$n_3 = 7$ rpm
Dwell	$T_4 = 0$ Nm,	$t_4 = 0.2$ sec,	$n_4 = 0$ rpm

$T_s = 500$ Nm, $t_s = 0.15$ sec, $n_s = 14$ rpm

$L_{10} = 7000$ hrs.

Oil Lubrication

T_{av} (Nm)

$$T_{av} = \sqrt[3]{\frac{7\text{rpm} \cdot 0.3\text{sec} \cdot |400\text{Nm}|^3 + 14\text{rpm} \cdot 3\text{sec} \cdot |320\text{Nm}|^3 + 7\text{rpm} \cdot 0.4\text{sec} \cdot |200\text{Nm}|^3}{7\text{rpm} \cdot 0.3\text{sec} + 14\text{rpm} \cdot 3\text{sec} + 7\text{rpm} \cdot 0.4\text{sec}}}$$

$$T_{av} = 319\text{Nm} < 451\text{Nm} \text{ (for CSF-40-120-2A-GR)}$$

no av (rpm)

$$\text{no av} = \frac{7\text{rpm} \cdot 0.3\text{sec} + 14\text{rpm} \cdot 3\text{sec} + 7\text{rpm} \cdot 0.4\text{sec}}{0.3\text{sec} + 3\text{sec} + 0.4\text{sec} + 0.2\text{sec}} = 12\text{rpm}$$

(R)

$$\frac{1800 \text{ rpm}}{14 \text{ rpm}} = 128.6 > 120$$

$$n_i \text{ av} = 12 \text{ rpm} \cdot 120 = 1440 \text{ rpm}$$

$$n_o \text{ max} \quad n_i \text{ max (rpm)}$$

$$n_i \text{ max} = 14 \text{ rpm} \cdot 120 = 1680 \text{ rpm}$$

$$n_i \text{ av} = 1440\text{rpm} < 3600 \text{ rpm} \text{ (for CSF-40-120-2A-GR)}$$

$$n_i \text{ max} = 1680\text{rpm} < 5600 \text{ rpm} \text{ (for CSF-40-120-2A-GR)}$$

OK

Confirm that T_1 and T_3 are within a

T_1, T_3 (Nm)

$$T_1 = 400\text{Nm} < 617\text{Nm} \text{ (for CSF-40-120-2A-GR)}$$

$$T_3 = 200\text{Nm} < 617\text{Nm} \text{ (for CSF-40-120-2A-GR)}$$

OK

T_s (Nm)

$$T_s = 500\text{Nm} < 1180\text{Nm} \text{ (for CSF-40-120-2A-GR)}$$

OK

(N_s) Calculate an allowable number of rotation(N_s) and confirm $\leq 1.0 \times 10^4$

$$N_s = \frac{10^4}{2 \cdot \frac{14\text{rpm} \cdot 120}{60} \cdot 0.15\text{sec}} = 1190 < 1.0 \times 10^4$$

OK

Calculate a life time.

$$L_{10} = 7000 \cdot \left(\frac{294\text{Nm}}{319\text{Nm}}\right)^3 \cdot \left(\frac{2000 \text{ rpm}}{1440 \text{ rpm}}\right)$$

$$L_{10} = 7610 > 7000 \text{ (} L_{B10} \text{)}$$

OK

CSF-40-120-2A-GR

WAVE GENERATOR COMPONENTS

- ① Ball Separator
- ② Wave Generator Bearing
- ③ Wave Generator Plug
- ④ Insert
- ⑤ Rub Washer
- ⑥ Snap Ring
- ⑦ Wave Generator Hub

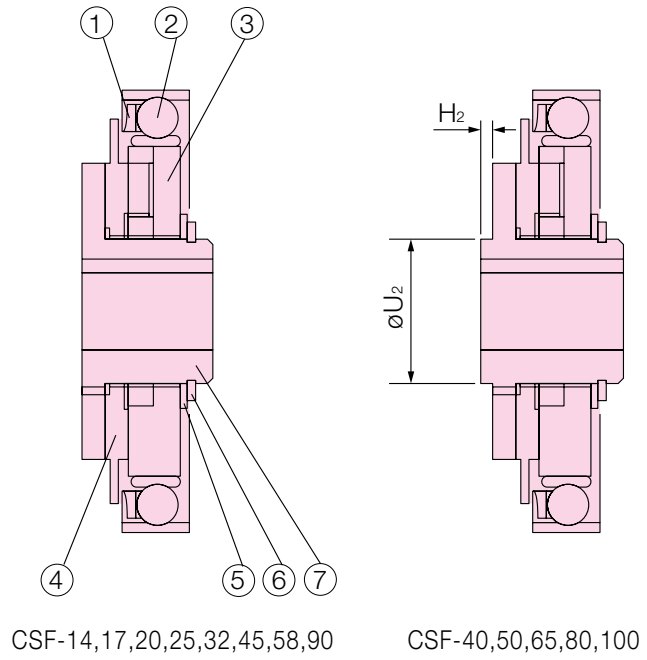

There is a difference in appearance of the the ball separator between CSF and CSG.
 (CSG size 14 and 17 use the same ball separator as CSF.)

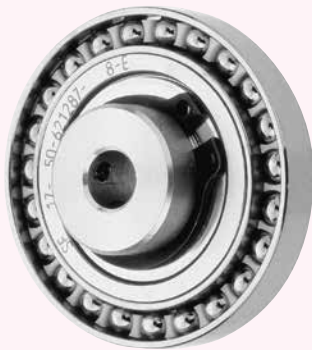

CSF ALL SIZES



CSG-20 AND ABOVE

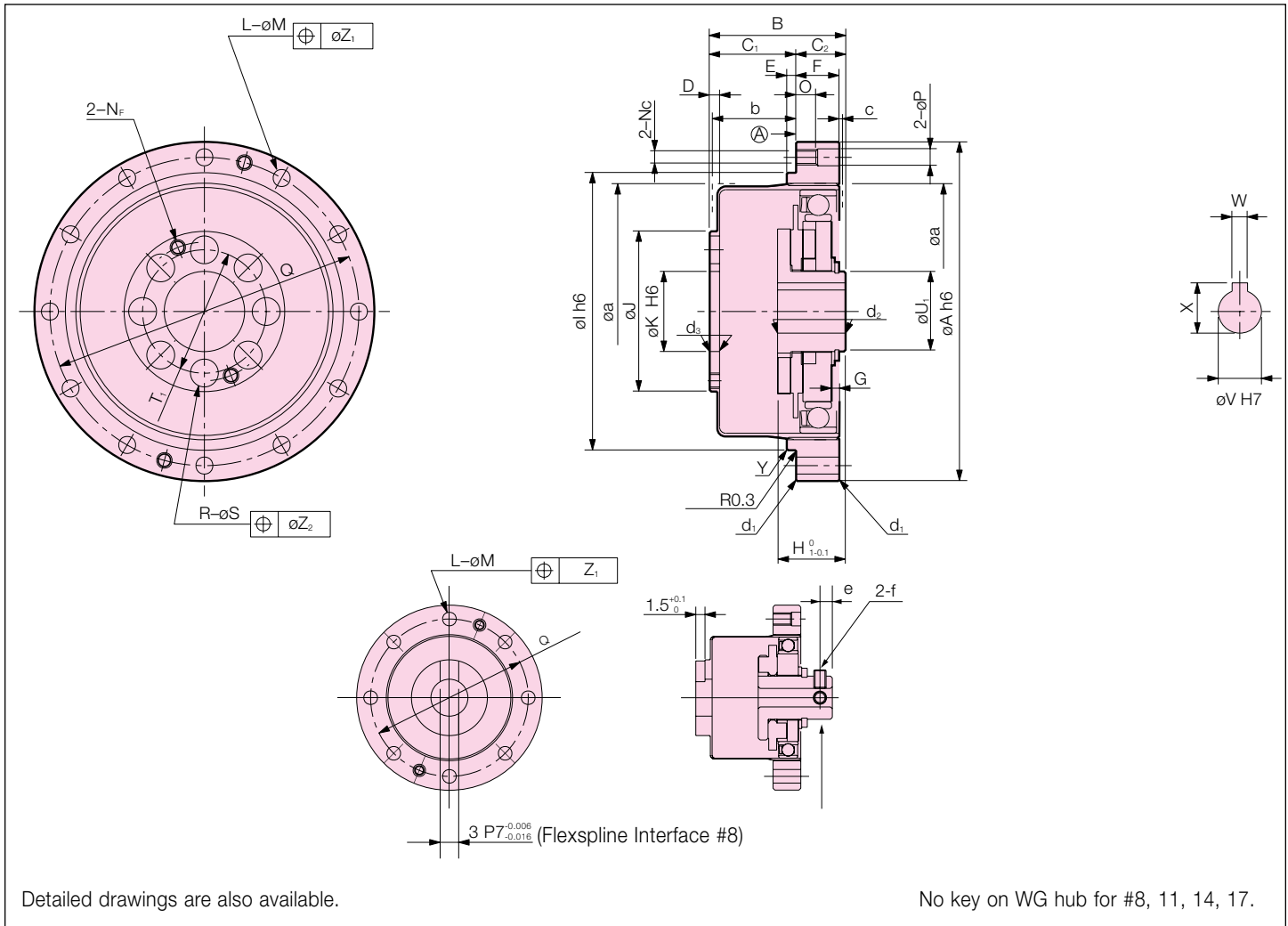

Dowel Pin Option

In cases where the gear will see loads near the Momentary Peak Torque level, the use of additional dowel pins in addition to the screws is recommended. Dowel pin holes are manufactured by reamer and the dimensions are shown. In addition, the CSF has a different number of dowel pin holes than the CSG.

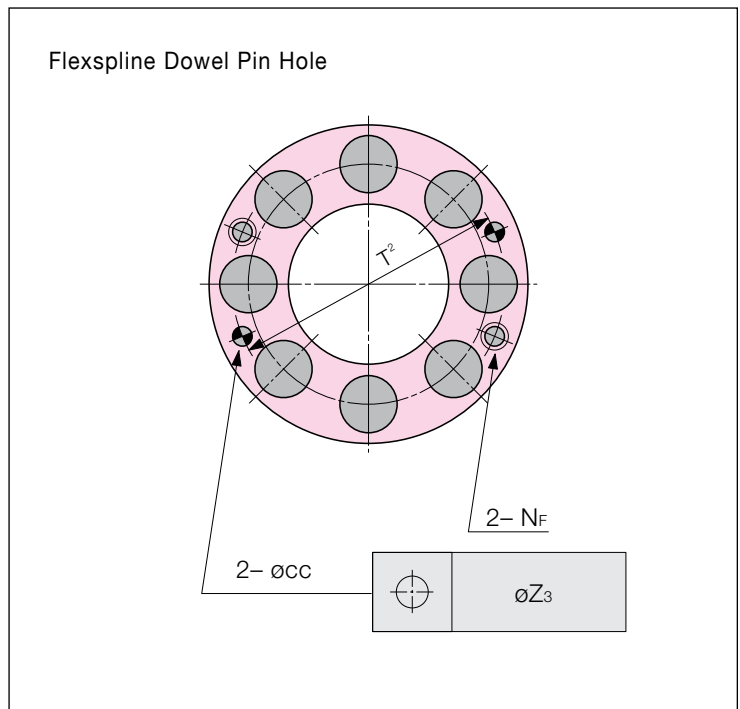

Table 8

		(mm)							
		8	11	14	17	20	25	32	40
	øA h6	30	40	50	60	70	85	110	135
B	CSF	22.1 _{-0.3} ⁰	25.8 _{-0.7} ⁰	28.5 _{-0.8} ⁰	32.5 _{-0.9} ⁰	33.5 _{-1.0} ⁰	37 _{-1.0} ⁰	44 _{-1.1} ⁰	53 _{-1.1} ⁰
	CSG	-	-	28.5 _{-0.4} ⁰	32.5 _{-0.4} ⁰	33.5 _{-0.4} ⁰	37 _{-0.5} ⁰	44 _{-0.6} ⁰	53 _{-0.6} ⁰
	C ₁	12.5 ₀ ^{+0.2}	14.5 ₀ ^{+0.4}	17.5 ₀ ^{+0.4}	20 ₀ ^{+0.5}	21.5 ₀ ^{+0.6}	24 ₀ ^{+0.6}	28 ₀ ^{+0.6}	34 ₀ ^{+0.6}
	C ₂	9.6	11.3	11	12.5	12	13	16	19
	D	2.7	2	2.4	3	3	3	3.2	4
	E	-	2	2	2.5	3	3	3	4
	F	4.5	5	6	6.5	7.5	10	14	17
G	CSF	-	-	0.4	0.3	0.1	2.1	2.5	3.3
	CSG	-	-	1.4	1.6	1.5	3.5	4.2	5.6
H ₁ 0 _{-0.1}	CSF	12	16	17.6	19.5	20.1	20.2	22	27.5
	CSG	-	-	18.5	20.7	21.5	21.6	23.6	29.7
	H ₂	-	-	-	-	-	-	-	0.4
øI h6	Ratio=30	-	31	38	48	54	67	90	110
	Ratio=30	-	31	38	48	55	68	90	-
	øJ	12.3	17.8	23	27.2	32	40	52	64
	øK H6	6	6	11	10	16	20	26	32
L	CSF	8	8	6	12	12	12	12	12
	CSG	-	-	8	16	16	16	16	16
	øM	2.2	2.9	3.5	3.4	3.5	4.5	5.5	6.6
	N _C	M2	M2.5	M3	M3	M3	M4	M5	M6
	N _F	-	-	M3	M3	M3	M4	M5	M6
	O	3	3	6	6.5	4	6	7	9
	øP	2.2	2.9	-	-	3.5	4.5	5.5	6.6
	Q(PCD)	25.5	35	44	54	62	75	100	120
	R	-	6	6	6	8	8	8	8
	øS	-	3.4	4.5	5.5	5.5	6.6	9	11
	T ₁ (PCD)	-	12	17	19	24	30	40	50
	T ₂ (PCD)	-	15.2	18.5	21.5	27	34	45	56
	øU ₁	7	11	14	18	21	26	26	32
	øU ₂	-	-	-	-	-	-	-	32
øV	(H7)standard	3	5	6	8	9	11	14	14
	maximum	-	-	8	10	13	15	15	20
	WJs9	-	-	-	-	3	4	5	5
	X	-	-	-	-	10.4 ₀ ^{+0.1}	12.8 ₀ ^{+0.1}	16.3 ₀ ^{+0.1}	16.3 ₀ ^{+0.1}
	Y	-	C0.2	C0.3	C0.4	C0.4	C0.4	C0.4	C0.4
	øZ ₁	0.1	0.2	0.25	0.20	0.25	0.25	0.25	0.3
	øZ ₂	-	0.2	0.25	0.25	0.25	0.3	0.5	0.5
	øZ ₃	-	0.02	0.02	0.02	0.02	0.02	0.02	0.02
øa		21.5	30	38	45	53	66	86	106
b	Minimum housing clearance	11.34	14	17.1	19	20.5	23	26.8	33
c		-	-	1	1	1.5	1.5	1.5	2
ø _{cc} H7	CSF	-	2	3	3	3	4	5	6
	CSG	-	-	2.5	3	3	4	5	5
	d ₁	C0.3	C0.4	C0.4	C0.4	C0.4	C0.4	C0.4	C0.4
	d ₂	C0.3	C0.4	C0.4	C0.4	C0.4	C0.4	C0.4	C0.4
	d ₃	C0.3	C0.3	C0.5	C0.5	C0.5	C0.5	C0.5	C0.5
	e	2	3	2.5	3	-	-	-	-
	f	M2X3	M3X4	M3X4	M3X6	-	-	-	-
	Weight (kg)	0.026	0.05	0.09	0.15	0.28	0.42	0.89	1.7

External Dimensions

Table 9 (mm)

	45	50	58	65	80	90	100
ØA h6	155	170	195	215	265	300	330
B	58.5 ⁰ _{-1.2}	64 ⁰ _{-1.3}	75.5 ⁰ _{-1.3}	83 ⁰ _{-1.3}	101 ⁰ _{-1.3}	112.5 ⁰ _{-1.4}	125 ⁰ _{-1.6}
C ₁	38 ^{+0.6} ₀	41 ^{+0.6} ₀	48 ^{+0.6} ₀	52.5 ^{+0.6} ₀	64 ^{+0.6} ₀	71.5 ^{+0.8} ₀	79 ^{+1.0} ₀
C ₂	20.5	23	27.5	30.5	37	41	46
D	4.5	5	5.8	6.5	8	9	10
E	4	4	5	5	6	6	6
F	19	22	25	29	36	41	46
G	CSF	3.7	4.2	4.8	5.8	6.6	8.3
	CSG	6.3	7	8.2	9.5	—	—
H ₁ ⁰ _{-0.1}	CSF	27.9	32	34.9	40.9	49.1	56.7
	CSG	30.5	34.8	38.3	44.6	—	—
H ₂	—	0.8	—	2.2	3.1	—	4.5
ØI h6	1/30 except	124	135	156	177	218	272
	1/30	—	—	—	—	—	—
ØJ	72	80	92.8	104	128	144	160
ØK H6	36	40	46	52	65	72	80
L	CSF	12	12	12	12	16	16
	CSG	16	16	16	16	—	—
ØM	9	9	11	11	11	14	14
N _C	M8	M8	M10	M10	M10	M12	M12
N _F	M6	M8	M8	M8	M8	M12	M10
O	12	13	15	15	15	18	20
ØP	9	9	11	11	11	14	14
Q(PCD)	140	150	175	195	240	270	300
R	8	8	8	8	10	8	12
ØS	13.5	15.5	15.5	18	18	22	22
T ₁ (PCD)	54	60	70	80	100	110	130
T ₂ (PCD)	61	68	79	90	114	120	142
ØU ₁	32	32	40	48	55	60	65
ØU ₂	—	32	—	48	55	—	65
ØV	(H7)Standard	19	19	22	24	28	28
	Maximum	20	20	25	30	35	40
WJs9	6	6	6	8	8	8	8
X	21.8 ^{+0.1} ₀	21.8 ^{+0.1} ₀	24.8 ^{+0.1} ₀	27.3 ^{+0.2} ₀	31.3 ^{+0.2} ₀	31.3 ^{+0.2} ₀	31.3 ^{+0.2} ₀
Y	C0.4	C0.8	C0.8	C0.8	C0.8	C0.8	C0.8
ØZ ₁	0.5	0.5	0.5	0.5	0.5	1.0	1.0
ØZ ₂	0.75	0.75	0.75	1.0	1.0	1.0	1.0
ØZ ₃	0.02	0.02	0.02	0.02	0.02	0.02	0.02
Øa	119	133	154	172	212	239	265
b Minimum housing clearance	36.5	39	46.2	50	61	68.5	76
c	2	2	2.5	2.5	3	3	3
Øcc H7	6	8	8	8	8	12	10
d ₁	C0.4	C0.4	C0.4	C0.4	C0.4	C0.4	C0.4
d ₂	C0.4	C0.4	C0.4	C0.4	C0.4	C0.4	C0.4
d ₃	C0.5	C0.5	C0.5	C0.5	C0.5	C0.5	C0.5
e	—	—	—	—	—	—	—
f	—	—	—	—	—	—	—
Weight (kg)	2.3	3.2	4.7	6.7	12.4	17.6	23.5

The pilot diameter for the Circular spline can be either ØI or ØA. Surface (A) is the recommended mounting surface.

The following parameters can be modified to accommodate customer-specific requirements.

Wave Generator: ØV, X, W

Flexspline: R, ØS

Circular Spline: ØM, L

Grease lubricant is the standard for the CSF and CSG units. The temperature range is shown below.

Lubricant	Type	Lubricant	Type	Temperature
Grease	Harmonic Grease	SK-1A	SK-1A	0°C~+40°C
Grease	Harmonic Grease	SK-2	SK-2	0°C~+40°C
Grease	Harmonic Grease	4B-No.2	4B-No.2	-10°C~+70°C
Oil	Industrial gear oil #2(high pressure)	ISO VG68	ISO VG68	0°C~+40°C

Harmonic Grease SK-1A - This grease is developed for a Harmonic Drive™ gear and features good durability and efficiency.

Harmonic Grease SK-2 - This grease is developed for a small size Harmonic Drive™ gear and features smooth rotation of the Wave Generator since high pressure additive is liquefied.

Harmonic Grease 4BNo.2 - This grease is developed for Harmonic Drive™ gears and features long life and a wide range of temperature.

Note 1 - Grease lubrication must have proper sealing, this is essential for 4B No.2.

Rotating part: Oil seal with spring is needed.

Mating part: O ring or seal adhesive is needed.

Note 2 - The grease has the highest deterioration rate in the region where the grease is subjected to the greatest shear (near wave generator). Its viscosity is between JIS No.0 and No.00 depending on the operation.

Ratio1/30

Size	14	17	20	25	32
SK-1A	—	—	○	○	○
SK-2	○	○	—	—	—
4BNo.2	△	△	●	●	●

●: recommended grease for long life and high load ○: Standard △: Semistandard

Ratio 1/50 and above

Size	14	17	20	25	32	40	45	50	58	65
SK-1A	—	—	○	○	○	○	○	○	○	○
SK-2	○	○	△	△	△	△	—	—	—	—
4BNo.2	●	●	●	●	●	●	●	●	●	●

●: recommended grease for long life and high load ○: Standard △: Semistandard

Characteristics of Grease

Grease	SK-1A	SK-2	4BNo.2
Durability	○	○	●
Fretting Resistance	○	○	●
Low Temp	△	△	●
Grease Leakage	●	●	△

●: Excellent ○: Good △: Exercise Caution

Recommended Grease

Grease	SK-1A	SK-2	4B No.2
Base Oil	Refined mineral hydrocarbon base oil	Refined mineral hydrocarbon base oil	Hydrocarbon type synthetic oil and polymer
Thickening Agent	Lithium soap thickener	Lithium soap thickener	Urea
Additive	Organic molybdenum, etc.	Organic molybdenum, etc.	Organic molybdenum, etc.s
NLGI Consistency No.	No.2	No.2	No.1.5
Viscosity (25C) cSt	265 to 295	265 to 295	290 to 320
Melting Point	197°C	198°C	247°C
Color	Yellow	Green	Light Yellow
Life	5 Years in Airtight Container		

Lubrication

Grease

Proper lubrication of the gear is essential for high performance and reliability.

Recommend grease:

SK-2 for sizes 8 thru 17

SK-1A for size 20 thru 65

Note: Harmonic Drive™ component sets are shipped with a rust-preventative oil. This oil is not sufficient for lubricating the gear, however, the appropriate grease may be applied directly on top of this rust-preventative oil.

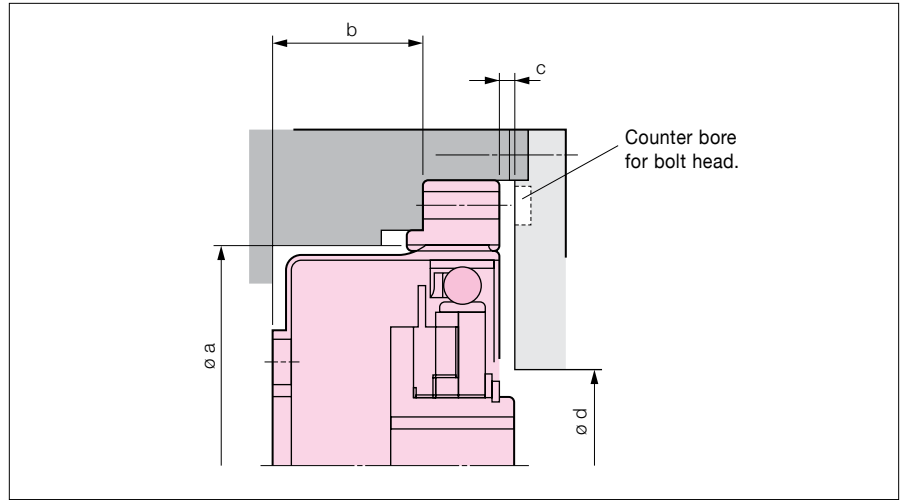

Recommended Tolerance for Inner Case Table 10

Size	8	11	14	17	20	25	32	40	45	50	58	65	80	90	100
øA	21.5	30	38	45	53	66	86	106	119	133	154	172	212	239	265
b	11.34	14	17.1	19	20.5	23	26.8	33	36.5	39	46.2	50	61	68.5	76
c	0.5	0.5	1	1	1.5	1.5	1.5	2	2	2	2.5	2.5	3	3	3
ød	13	16	16	26	30	37	37	45	45	45	56	62	67	73	79

Grease Usage Table 11

Size	8	11	14	17	20	25	32	40	45	50	58	65	80	90	100
Horizontal	1.2	2.9	5.5	10	16	30	60	110	170	220	360	460	850	1150	1500
Output Up	1.4	3.5	7	12	18	35	70	125	190	240	380	500	900	1300	1700
Output Down	1.8	4.4	8.5	14	21	40	80	145	220	275	460	600	1000	1500	1900

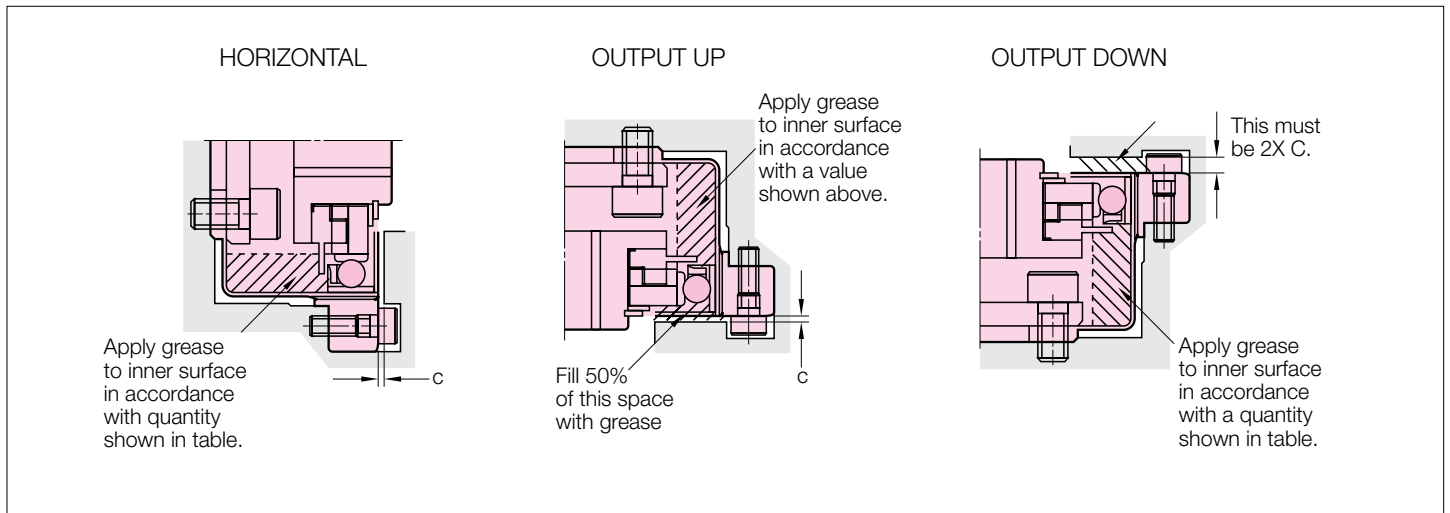
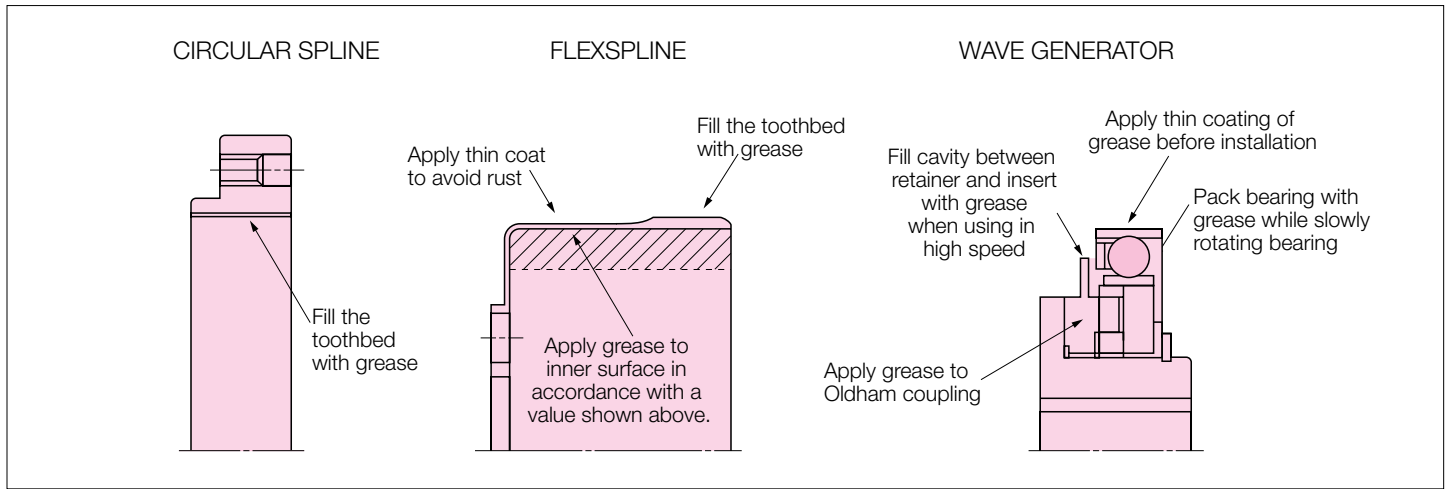

Grease Change

The wear characteristics of the gear are strongly influenced by the condition of the grease lubrication. The condition of the grease is affected by the ambient temperature. The graph shows the maximum number of input rotations for various temperatures. This graph applies to applications where the average load torque does not exceed the rated torque.

Note: Recommended Grease: SK-1A or SK-2

In cases where the rated torque is exceeded, calculate the grease change interval using the equation shown below.

Equation where average load torque exceeds rated torque
 [Equation 9]

$$L_{GT} = L_{GTn} \times \left(\frac{T_r}{T_{av}} \right)^3$$

Symbol of Equation	
L_{GT}	Grease change (over rated torque), input rotations
L_{GTn}	Grease change (below rated torque), input rotations (From Graph)
T_r	Rated Torque
T_{av}	Average load torque on output

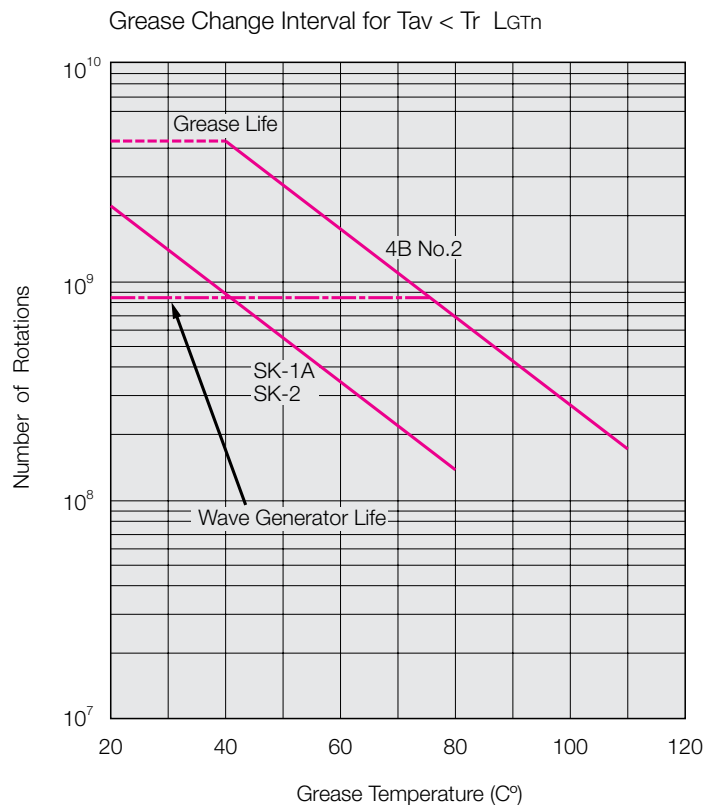

Lubrication

Oil Lubricant

Kind of Lubricant

Name of Lubricant Table 12

Industrial	Mobil	Exxon	Showa Shell	Cosmo	Japan Energy	Shin Nippon Oil	Idemitsu Kosan	General oil	NOK Kluber
Industrial Gear Oil#2 ISO VG68 (extreme pressure)	Mobil gear 626	Spartan EP68	Omara oil 68	Cosmo gear SE68	ES gear G68	Bonnock M68	Dafuni Supergear LW68	General Oil SP gear Roll 68	Shin tesso DE-68 EP

Oil Level of Horizontal Usage Table 13

Size	8	11	14	17	20	25	32	40	45	50	58	65	80	90	100
A	6	8	10	12	14	17	24	31	35	38	44	50	59	66	74

Horizontal Installation:

Oil level should be maintained at the level "A" as shown.

Oil Level for Horizontal Usage

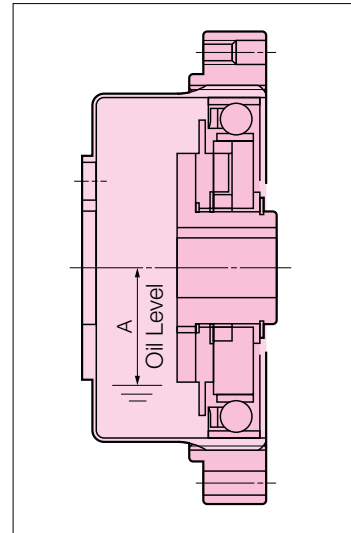

Oil Level of Vertical Usage Table 14

Size	8	11	14	17	20	25	32	40	45	50	58	65	80	90	100
B	2	2.3	2.5	3	3	5	7	9	10	12	13	15	19	22	25

Vertical Installation:

If the input shaft is on top, lube holes are provided on the boss of the Flexspline to facilitate the flow of oil inside the Flexspline cup. The lube holes serve as breathers if the component set is used with input down.

When the Harmonic Drive™ gear is to be used vertically with the Wave Generator placed at the bottom, special consideration must be given. If the Wave Generator assembly is completely submerged in oil, the heat generation caused by churning oil will be substantial and a loss of efficiency will result. It is recommended that the oil level be maintained in such a way that approximately one half of the Wave Generator Bearing is submerged.

Oil level should be maintained at the level "B" shown.

To ensure a sufficient amount of lubricant it may be necessary to extend the bottom area of the housing or to provide an external oil reservoir. A forced lubrication system may also be considered.

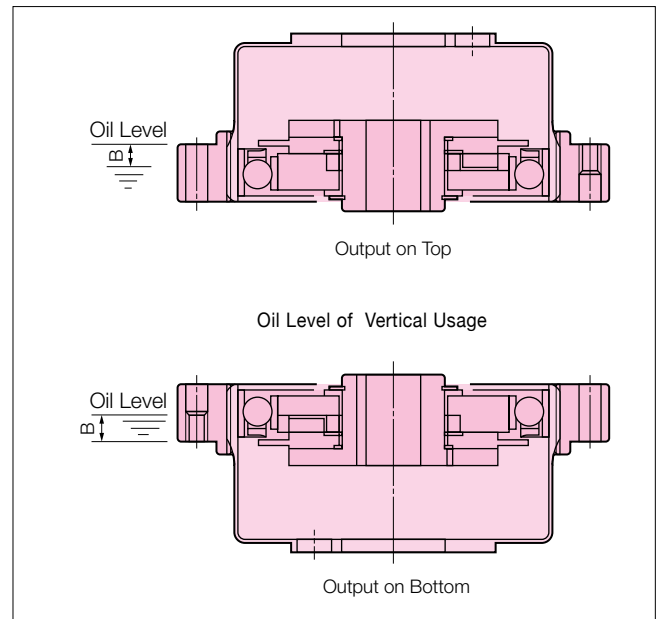

Dimension of Lube Hole of Flexspline Table 15

Size	20	25	32	40	45	50	58	65	80	90	100	mm
T ₂	27	34	45	56	61	68	79	90	114	120	142	
B	2.5	2.5	3.5	3.5	3.5	5.5	5.5	5.5	6.5	6.5	6.5	
W	2.8	3.5	4.0	4.0	4.0	6.0	6.0	6.0	7.0	7.0	7.0	
t	1.2	1.2	1.4	1.4	1.4	2	2	2	3	3	3	

Size 8, 11, 14, 17 do not have any lube holes

Dimension of lube hole in Flexspline

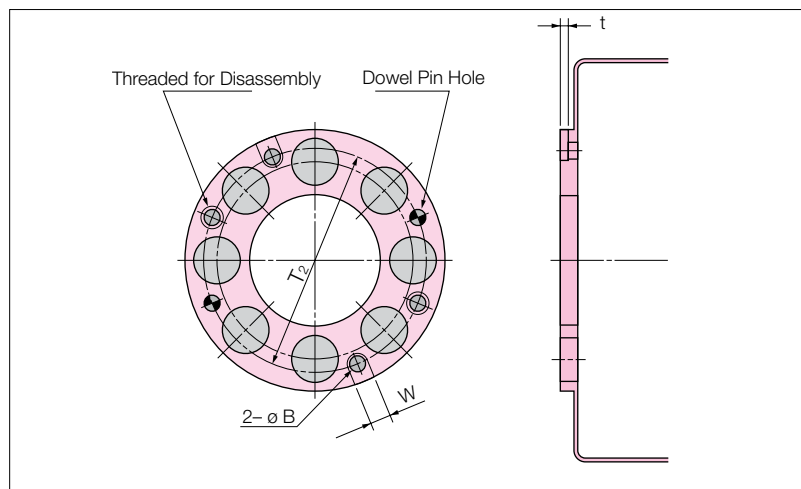

Oil Quantity Table 16

Size	8	11	14	17	20	25	32	40	45	50	58	65	80	90	100	liters
B Amount of Oil	0.004	0.006	0.01	0.02	0.03	0.07	0.13	0.25	0.32	0.4	0.7	1.0	2.0	2.8	3.8	

Oil Temperature

In normal use, the oil temperature must not exceed 90°C, Above this temperature oil quickly loses its lubricating capabilities.

Oil Change

The first oil change should be performed after 100 hours of operation. The need to perform subsequent oil changes will depend on operating conditions, but should take place at intervals of approximately 1000 running hours.

Other notes: Avoid mixing different kinds of oil. The gear should be in an individual case when installed.

High Temperature Lubricants

Harmonic Grease 4B No.2

Type of lubricant	Standard temperature range	Possible temperature range
grease	-10°C~+110°C	-50°C~+130°C

High Temperature Lubricant

Type of lubricant	Name of lubricant and manufacturer	Possible temperature range
Mobil grease 28	Mobil Grease 28	-5°C~+160°C
oil	Mobil SHC-626	-5°C~+140°C

High Temperature Lubricant

Type of lubricant	Name of lubricant and manufacturer	Possible temperature range
grease	Multemp SH-K2 Kyodo Yushi	-30°C~+50°C
	Multemp AC-N Kyodo Yushi	-55°C~+60°C
	Iso Flex LDS-18 special A NOK kluber	-25°C~+80°C
oil	SH-200-100CS Tore Silicon	-10°C~+110°C
	Shintesso D-32EP NOK kluber	-25°C~+90°C

Standard temperature is the grease temperature during operation. It is not the ambient temperature.

The temperature range of the grease can be extended as indicated in the possible temperature range shown. At the low end of this range the efficiency will be low due to an increase in viscosity of the lubricant. At the high end of this range the lubricant life will be low due to an increased deterioration rate from the high temperature.

Recommended Tolerances for Assembly

For peak performance of the CSF Component Set it is essential that the following tolerances be observed when assembly is complete.

Recommended tolerances for assembly

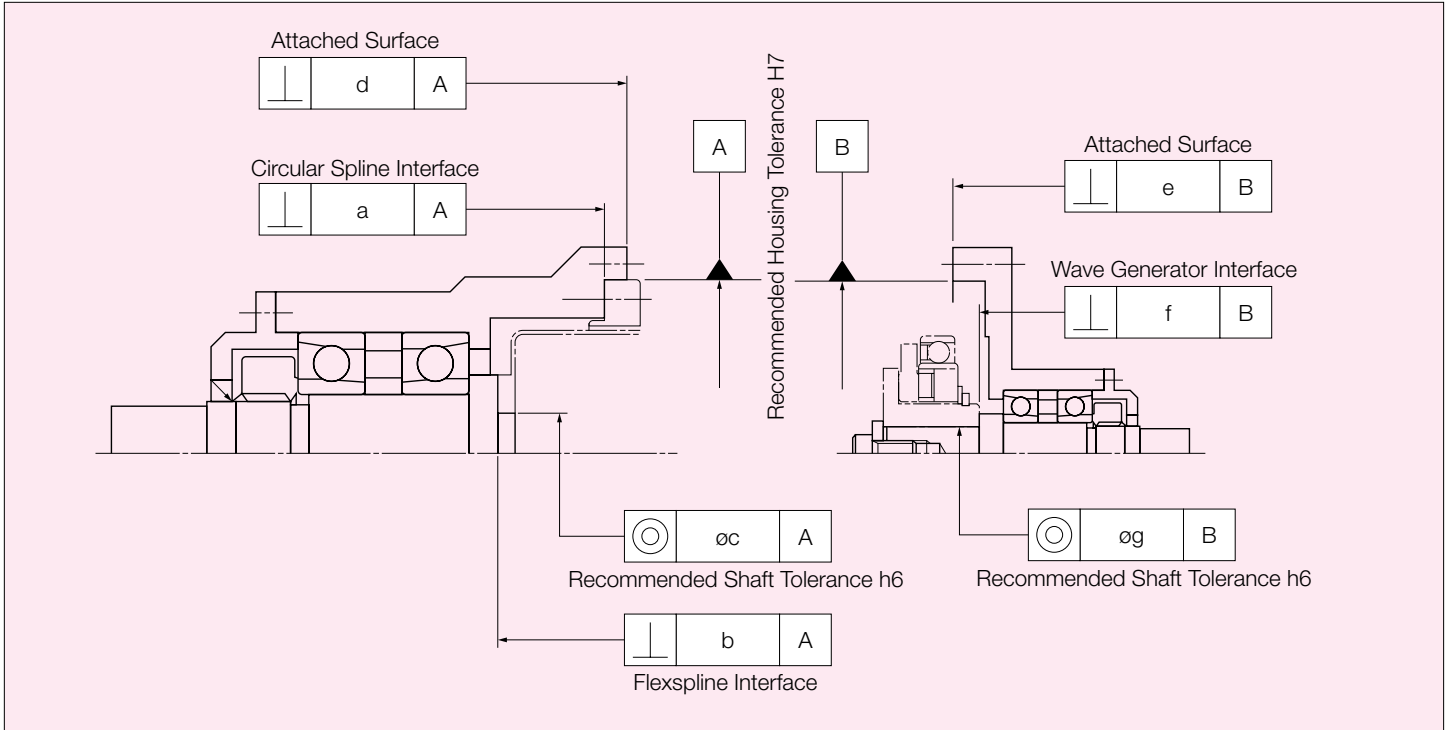

Tolerances for Assembly Table 17

Size	8	11	14	17	20	25	32	40	45	50	58	65	80	90	100
a	0.008	0.011	0.011	0.012	0.013	0.014	0.016	0.016	0.017	0.018	0.020	0.023	0.027	0.029	0.031
b	0.006	0.006	0.008	0.011	0.014	0.018	0.022	0.025	0.028	0.030	0.032	0.035	0.040	0.043	0.045
øc	0.005	0.008	0.015	0.018	0.019	0.022	0.022	0.024	0.027	0.030	0.032	0.035	0.043	0.046	0.049
d	0.010	0.010	0.011	0.015	0.017	0.024	0.026	0.026	0.027	0.028	0.031	0.034	0.043	0.050	0.057
e	0.010	0.010	0.011	0.015	0.017	0.024	0.026	0.026	0.027	0.028	0.031	0.034	0.043	0.050	0.057
f	0.012	0.012	0.017	0.020	0.020	0.024	0.024	0.032	0.032	0.032	0.032	0.032	0.036	0.036	0.036
øg	0.015	0.015	(0.008)	(0.010)	(0.010)	(0.012)	(0.012)	(0.012)	(0.013)	(0.015)	(0.015)	(0.015)	(0.015)	(0.015)	(0.015)
			(0.016)	(0.018)	(0.019)	(0.022)	(0.022)	(0.024)	(0.027)	(0.030)	(0.033)	(0.035)	(0.043)	(0.046)	(0.049)

The values in parentheses indicate that Wave Generator does not have an Oldham coupling.

Sealing structure

A seal structure is needed to maintain the high durability of the gear and prevent grease leakage.

Key Points to Verify

- Rotating parts should have an oil seal (with spring), surface should be smooth (no scratches)
- Mating flanges should have an O Ring, seal adhesive
- Screws should have a thread lock
(Loctite 242 recommended) or seal adhesive.

(note)

If you use Harmonic grease 4BNo.2, strict sealing is required.

Hole Diameter of Wave Generator Hub

Table 18
Unit: mm

Size	8	11	14	17	20	25	32	40	45	50	58	65	80	90	100
Standard Dimension	3	5	6	8	9	11	14	14	19	19	22	24	28	28	28
Minimum Hole Dimension	-	-	3	4	5	6	6	10	10	10	13	16	16	19	22
Maximum Hole Dimension	-	-	8	10	13	15	15	20	20	20	25	30	35	37	40

Hole Diameter of Wave Generator

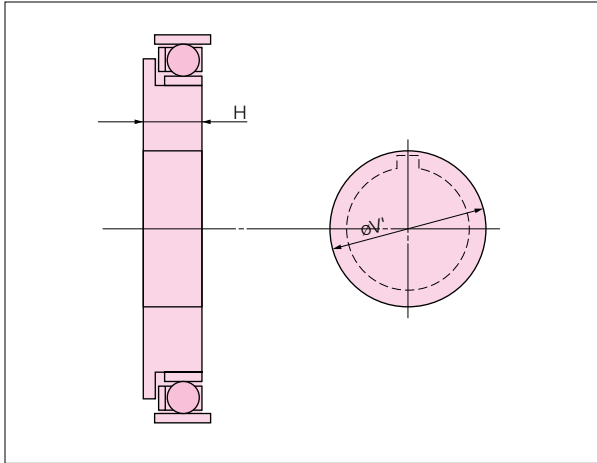

Installation of Three Basic Elements

Installation for Wave Generator and the maximum hole dimensions.

Shown above is the standard hole dimension of the Wave Generator for each size. The dimension can be changed within a range up to the maximum hole dimension shown in table 18. We recommend the dimension of keyway based on JIS standard. It is necessary that the dimension of keyways should sustain the transmission torque.

Please note: Tapered holes are also available.

In cases where a larger hole is required, use the Wave Generator without the Oldham coupling. The maximum diameter of the hole should be considered to prevent deformation of the Wave Generator plug by load torque.

The dimension is shown in table 19 include the dimension of depth of keyway.

Maximum Diameter or Hole without Oldham Coupling

Table 19
Unit: mm

Size	8	11	14	17	20	25	32	40	45	50	58	65	80	90	100
Maximum Diameter øV'	10	14	17	20	23	28	36	42	47	52	60	67	72	84	95
Min. thickness of plug H	5.7	6.7	7.2	7.6	11.3	11.3	13.7	15.9	17.8	19	21.4	23.5	28.5	31.3	34.9

Direction for Thrust Force of Wave Generator

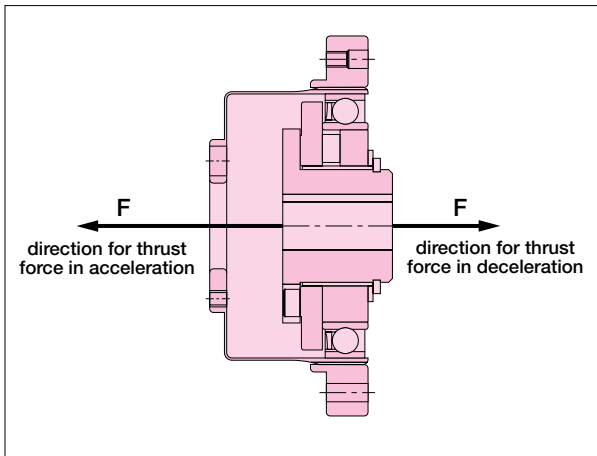

Axial Force of Wave Generator

When a CSF/CSG gear is used to accelerate a load, the deflection of the Flexspline leads to an axial force acting on the Wave Generator. This axial force, which acts in the direction of the closed end of the Flexspline, must be supported by the bearings of the input shaft (motor shaft).

When a CSF/CSG gear is used to decelerate a load, an axial force acts to push the Wave Generator out of the Flexspline cup. Maximum axial force of the Wave Generator can be calculated by the equation shown below. The axial force may vary depending on its operating condition. The value of axial force tends to be a larger number when using high torque, extreme low speed and constant operation. The force is calculated (approximately) by the equation. In all cases, the Wave Generator must be axially (in both directions), as well as torsionally, fixed to the input shaft.

(note) Please contact us when you fix the Wave Generator hub and input shaft using bolts.

Equation for axial force

Gear Ratio	equation
i=1/30	$F=2x\frac{T}{D} \times 0.07 \times \tan 32^\circ$
i=1/50	$F=2x\frac{T}{D} \times 0.07 \times \tan 30^\circ$
i=1/80 and up	$F=2x\frac{T}{D} \times 0.07 \times \tan 20^\circ$

Symbols for equation

F	axial force	N
D	Gear Size x 0.00254	m
T	output torque	Nm

Calculation Example

size	:	32
Ratio	:	i=1/50
Output Torque	:	300Nm
$F=2x\frac{300}{(32x0.00254)} \times 0.07 \times \tan 30^\circ$		
F=298N		

Assembly of the Flexspline

Shape and dimension of Wave Generator

There is a difference between CSF series and CSG series with regard to the shape and dimension of the Wave Generator. Table 20 and Figure 5 show the comparison of the shape and dimension for the Wave Generator.

During design and installation, please ensure there is no interference between the bolt of the Wave Generator and Flexspline.

Size		14	17	20	25	32	40
G	CSF	0.4	0.3	0.1	2.1	2.5	3.3
	CSG	1.4	1.6	1.5	3.5	4.2	5.6
H_1	CSF	17.6	19.5	20.1	20.2	22	27.5
	CSG	18.5	20.7	21.5	21.6	23.6	29.7
t	CSF	2.5	2.5	2.9	2.8	3.8	4.5
	CSG	1.6	1.3	1.5	1.4	2.2	2.3

G indicates Wave Generator depth inside the Flexspline measured from the open end of the Flexspline cup.
t indicates the clearance between hub and Flexspline bolts.

Figure 5. Comparison of shape for Wave Generator

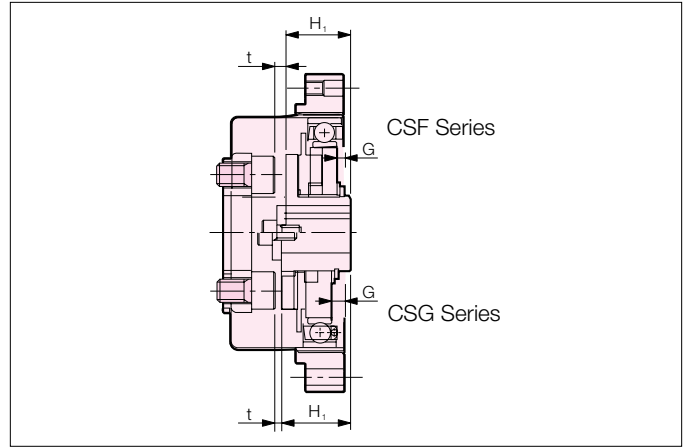

Installation of Flexspline

1. Size #8

- For installation of the Flexspline on the output shaft use the plug shown on the right.
- The positioning of the output shaft and the Flexspline should be determined using the plug.
- We recommend using an M3 socket head cap screw for connecting the plug to the output shaft. We also recommend using Loctite 242.
- The open end of the Flexspline must be located axially on the same plane as the top surface of the circular spline.

2. Recommended dimensions for Flexspline Clamp Rings required for sizes 11 and larger.

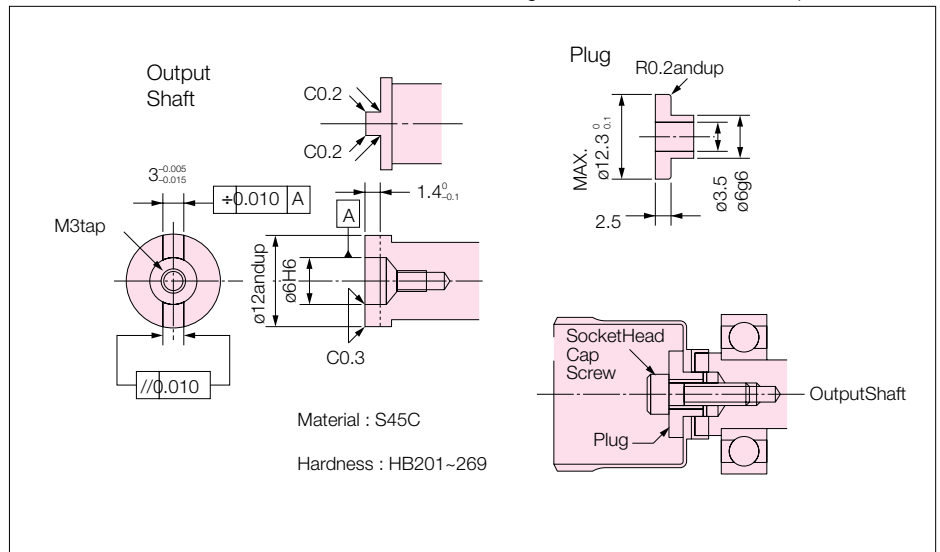

Figure 6. Installation for Flexspline of Size 8

Size	11	14	17	20	25	32	40	45	50	58	65	80	90	100
ϕD	17.8	24.5	29	34	42	55	68	74	83	95.8	106	130	145	162
R	0.5	1.2	1.2	1.4	1.5	2	2.5	2	2.5	2.5	2.5	2.5	2.5	2.5
t	2	2	2.5	2.5	5	7	7	8	8	12	12	15	20	25

For installation, the flange diameter should not exceed the boss diameter of Flexspline shown on figure 7. The flange which contacts the diaphragm should have radius, R. A large diameter and flange without a radius may cause damage to the diaphragm.

3. Material and hardness for flange installation.

- Material : S45C (DIN C45)
- Hardness : HB200~270

Note: For proper lubrication, please refer to lubrication requirements, p. 21.

Recommended Dimensions of Flexspline Clamp Ring

Figure 7

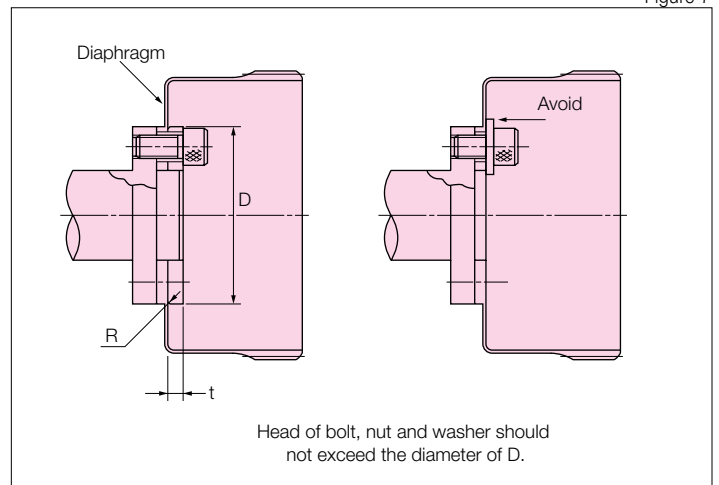

Installation of the Flexspline

The load is normally attached to the Flexspline using a bolt or screw. For high load torques dowel pins can be used in addition to bolts or screws.

The strength of the selected bolt, clamp torque, surface condition of bolt and thread, and coefficient of friction on the contact surface are important factors to consider.

To determine transmission torque of the fastened part consider conditions indicated above.

Please fasten bolts with the proper torque for each size as indicated. Please use the table shown below to decide if dowel pins are needed.

1. If the load torque is less than momentary peak torque shown on tables 1, 2, 3, then only bolts are needed.
2. If the load torque is expected to reach momentary peak torque, both bolts and pins should be used.

Use values on the list as a reference.

Tables 22, 23 pertain to the CSF series.
Tables 24, 25 pertain to the CSG series.

CSF Series Flexspline Bolts

Table 22

Size	11	14	17	20	25	32	40	45	50	58	65	80	90	100
Number	6	6	6	8	8	8	8	8	8	8	8	10	8	12
Size	M3	M4	M5	M5	M6	M8	M10	M12	M14	M14	M16	M16	M20	M20
Pitch circle mm	12	17	19	24	30	40	50	54	60	70	80	100	110	130
Clamp Torque Nm	2.0	4.5	9.0	9.0	15.3	37	74	128	205	205	319	319	622	622
Torque Transmission Capacity(bolt only)Nm	15	35	64	108	186	460	910	1440	2160	2550	3980	6220	8560	15170

CSF Series Flexspline Screws and Optional Dowel Pins

Table 23

Size	11	14	17	20	25	32	40	45	50	58	65	80	90	100
Number	2	2	2	2	2	2	2	2	2	2	2	2	2	2
Diameter mm	2	3	3	3	4	5	6	6	8	8	8	8	12	10
Pitch circle mm	15.2	18.5	21.5	27	34	45	56	61	68	79	90	114	120	142
Torque Transmission Capacity(bolt&pin) Nm	29	74	108	167	314	725	1370	1950	3160	3710	5310	7910	12540	18450

1. The material of the thread must withstand the clamp torque.
2. Recommended bolt : JIS B 1176 socket head cap screw strength range : JIS B 1051 over 12.9
3. Torque coefficient : $K=0.2$
4. Clamp coefficient $A=1.4$
5. Friction coefficient on the surface contacted: 0.15
6. Dowel Pin: parallel pin Material: S45C-Q Shear stress: 30 kgf/mm²

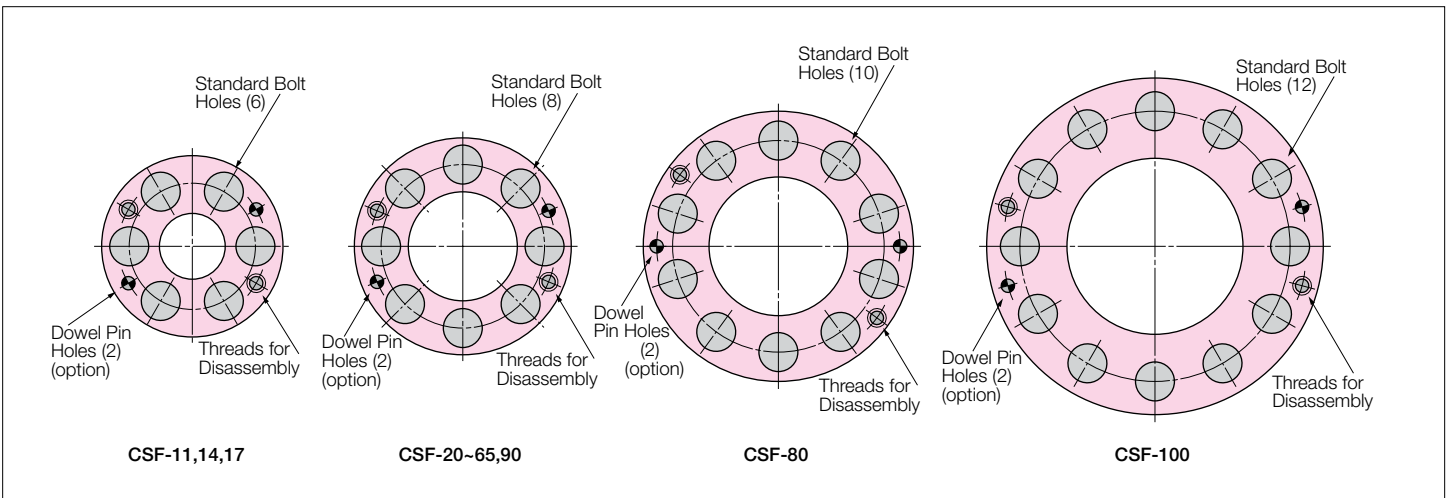

CSG Series - Flexspline Bolts

Table 24

Size	14	17	20	25	32	40
Number	6	6	8	8	8	8
Size	M4	M5	M5	M6	M8	M10
Pitch Circle mm	17	19	24	30	40	50
Clamp torque Nm	5.4	10.8	10.8	18.4	44.4	88.8
Torque transmission capacity (bolt only) Nm	43	77	130	230	555	1110

Assembly of Circular Spline

CSG Series - Screws, Bolts and Optional Dowel Pins

Table 25

Size	14	17	20	25	32	40
Dowel pin number	4	4	4	4	4	4
Dowel pin diameter	3	3	3	4	5	6
Pitch circle dia mm	18.5	21.5	27	34	45	56
Torque transmission capacity(bolt&pin) Nm	120	166	242	481	1070	2040

1. The material of the thread must withstand the clamp torque.
2. Recommended bolt : JIS B 1176 socket head cap screw strength range : JIS B 1051 over 12.9
3. Torque coefficient : K=0.2
4. Clamp coefficient A=1.4
5. Friction coefficient on the surface contacted: 0.15
6. Dowel Pin: parallel pin Material:S45C-Q Shear stress: 30 kgf/mm²

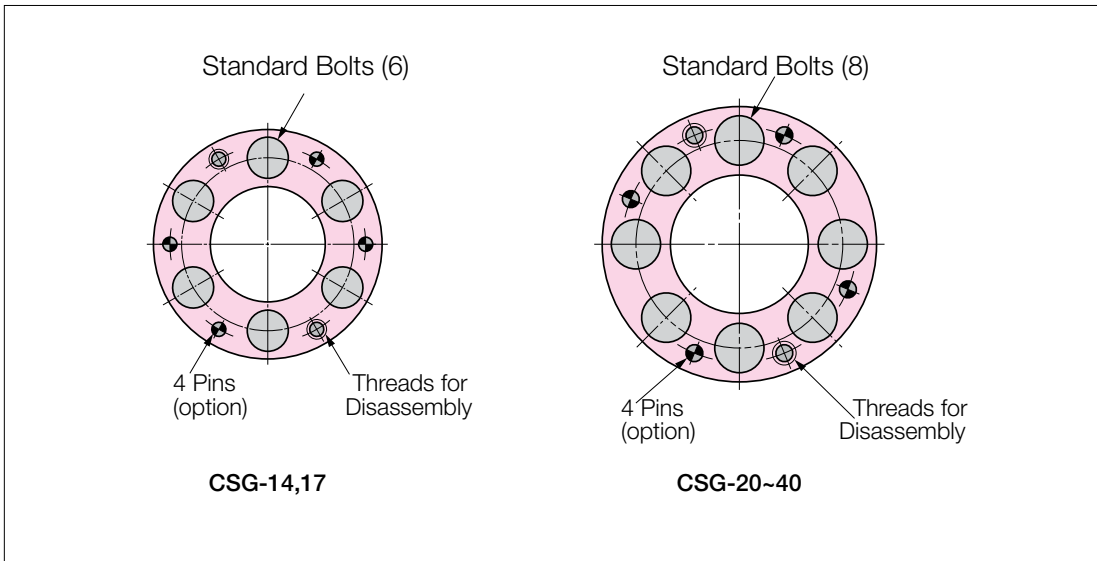

Installation of Circular Spline

CSF Bolt Installation

Table 26

Size	8	11	14	17	20	25	32	40	45	50	58	65	80	90	100
Number	8	8	6	12	12	12	12	12	12	12	12	12	16	16	16
Size	M2	M2.5	M3	M3	M3	M4	M5	M6	M8	M10	M10	M10	M10	M12	M12
Pitch circle mm	25.5	35	44	54	62	75	100	120	140	150	175	195	240	270	300
Clamp Torque Nm	0.17	0.35	2.0	2.0	2.0	4.5	9.0	15.3	37	37	74	74	74	7128	128
Torque transmission capacity Nm	5	12	54	131	147	314	676	1150	2440	2620	4820	5370	8820	14450	16050

CSG Bolt Installation

Table 27

Size	14	17	20	25	32	40
Number	8	16	16	16	16	16
Size	M3	M3	M3	M4	M5	M6
Pitch circle mm	44	54	62	75	100	120
Clamp torque Nm	2.0	2.0	2.0	4.5	9.0	15.3
Torque transmission capacity Nm	72	175	196	419	901	1530

1. The material of the thread must withstand the clamp torque.
2. Recommended bolt : JIS B 1176 socket head cap screw strength range : JIS B 1051 over 12.9
3. Torque coefficient : K=0.2
4. Clamp coefficient A=1.4
5. Friction coefficient on the surface contacted: 0.15
6. The open end of the Flexspline must be located axially on the same plane as the top surface of the circular spline.

7. Ensure that the surface used for installation is flat and not skewed.
8. Ensure that the installation surface does not have any burrs or foreign substances resulting from screw threading operations.
9. Ensure sufficient clearance to prevent interference between the Flexspline and installed parts.
10. When a bolt is inserted into a bolt hole during installation, make sure that the bolt fits securely and is not in an improper position or inclination.
11. Do not apply torque at recommended torque all at once. First, apply torque at about half of the recommended value to all bolts, then tighten at recommended torque. Order of tightening bolts must be diagonal.
12. Ensure that the Flexspline and Circular spline are concentric after assembly.
13. Do not damage Flexspline diaphragm or gear teeth during assembly.

Note: For proper lubrication, please refer to lubrication requirements, p. 21-24.

Assembly Order for Basic Three Elements

The recommended sequences of assembly are illustrated below.

Only after the Circular Spline and Flexspline are assembled in equipment is the Wave Generator assembled.

If assembly is performed using a different method, Dedoidal assembly or teeth breakage may occur.

It is essential that teeth of the Flexspline and Circular Spline mesh symmetrically for proper function.

An eccentric tooth mesh (Dedoidal), will result in noise and vibration and may lead to early failure of the gear.

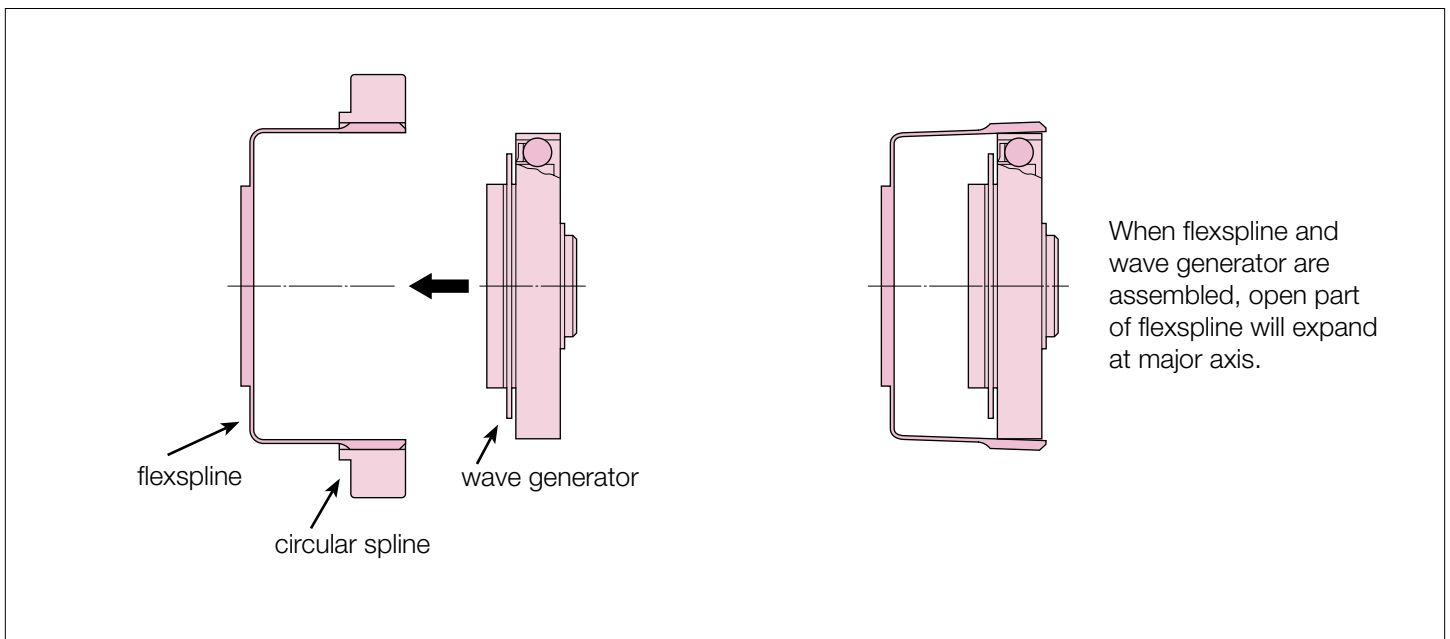

Note:

1. Avoid assembling with excessive force on Wave Generator bearing. Insert Wave Generator as you rotate it.
2. If the Wave Generator does not have an Oldham coupling, special consideration must be given to ensure that concentricity and inclination are within the specified limits. (see page 24).

External Dimensions of Housed Unit

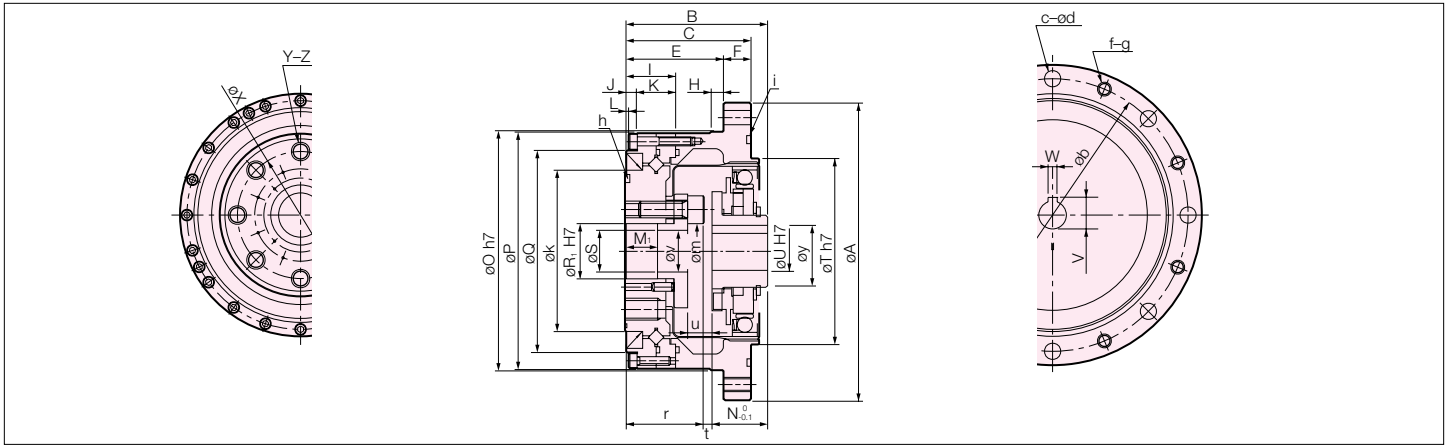

Note: Please note that the engagement length of bolt is within the length of threaded hole. Bolts that are too long may cause damage to Flexspline.
The shape of the output flange may vary by size. Please contact our engineers for more detailed information.

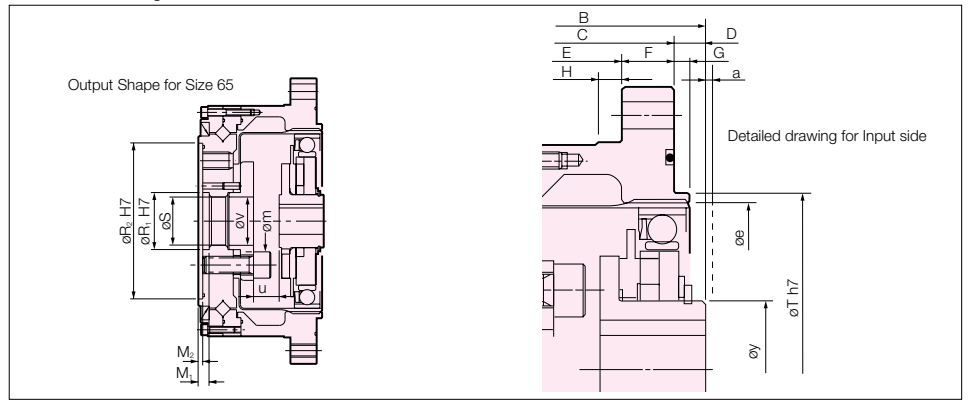
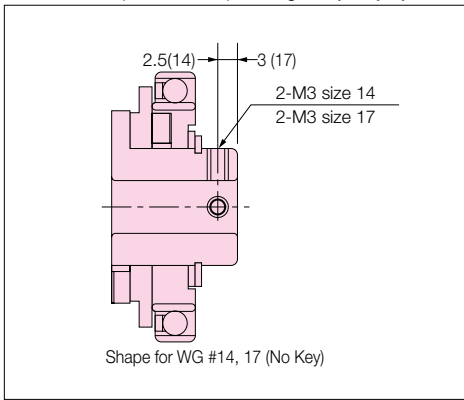

Dimensions

Table 28

	14	17	20	25	32	40	45	50	58	65	
øA	73	79	93	107	138	160	180	190	226	260	
B	41 ^{0.9} ₀	45 ^{0.9} ₀	45.5 ^{1.0} ₀	52 ^{1.0} ₀	62 ^{1.1} ₀	72.5 ^{1.1} ₀	79.5 ^{1.2} ₀	90 ^{1.3} ₀	104.5 ^{1.3} ₀	115 ^{1.3} ₀	
C	34	37	38	46	57	66.5	74	85	97	108.5	
D	CSF	7	8	7.5	6	5	6	5.5	5	7.5	6.5
	CSG	7 ^{0.4} ₀	8 ^{0.4} ₀	7.5 ^{0.4} ₀	6 ^{0.5} ₀	5 ^{0.6} ₀	6 ^{0.6} ₀	-	-	-	-
E	27	29	28	36	45	50.5	58	69	77	84.5	
F	7	8	10	10	12	16	16	16	20	24	
G	2	2	3	3	3	4	4	4	5	5	
H	3.5	4	5	5	5	5	6	6	6	6	
I	16.5	16.5	16.5	18.5	22.5	24	27	31	35	39	
J	4.5	4.5	4	4.5	5.5	7.5	7	8	8.5	8.5	
K	12	12	12.5	14	17	16.5	20	23	26.5	30.5	
L	0.5	0.5	0.5	0.5	1	1.5	1	1	1.5	2	
M	M ₁	9.4	9.5	9	12	15	5	6	8	10	10
	M ₂	-	-	-	-	-	-	-	-	-	4
N ^{0.1} ₀	CSF	17.6	19.5	20.1	20.2	22	27.5	27.9	32	34.9	40.9
	CSG	18.5	20.7	21.5	21.6	23.6	29.7	30.5	34.8	38.3	44.6
øOh7	56	63	72	86	113	127	148	158	186	212	
øP	55	62	70	85	112	126	147	157	185	210	
øQ	42.5	49.5	58	73	96	109	127	137	161	186	
øR ₁ H7	11	10	14	20	26	32	32	40	46	52	
øR ₂ H7	-	-	-	-	-	-	-	-	-	142	
øS	8	7	10	15	20	24	25	32	38	44	
øT h7	38	48	56	67 (68)*	90	110	124	135	156	177	
øU* H7	6	8	12	14	14	14	19	19	22	24	
V*	-	-	13.8 ^{+0.1} ₀	16.3 ^{+0.1} ₀	16.3 ^{+0.1} ₀	16.3 ^{+0.1} ₀	21.8 ^{+0.1} ₀	21.8 ^{+0.1} ₀	24.8 ^{+0.1} ₀	27.3 ^{+0.2} ₀	
W* J _S 9	-	-	4	5	5	5	6	6	6	8	
øX	23	27	32	42	55	68	82	84	100	110	

* Dimensions in parentheses indicates ratio 30:1

Dimensions (mm)

Table 29

	14	17	20	25	32	40	45	50	58	65
Y	6	6	8	8	8	8	8	8	8	8
Z	M4X8	M5X10	M6X9	M8X12	M10X15	M10X15	M12X18	M14X21	M16X24	M16X24
a	1	1	1.5	1.5	1.5	2	2	2	2.5	2.5
øb	65	71	82	96	125	144	164	174	206	236
c	CSF	6	6	6	8	12	8	12	12	8
	CSG	8	8	8	10	12	10	12	14	8
	ød	4.5	4.5	5.5	5.5	6.6	9	9	9	11
øe	38	45	53	66	86	106	119	133	154	172
f	CSF	6	6	6	8	12	8	12	12	8
	CSG	8	8	8	10	12	10	12	14	8
g	M4	M4	M5	M5	M6	M8	M8	M8	M10	M12
h	29.0X0.50	34.5X0.80	40.64X1.14	53.28X0.99	S71	AS568-042	S100	S105	S125	S135
i	S50	S56	S67	S80	S105	S125	S145	S155	S180	S205
øk	31	38	45	58	78	90	107	112	135	155
øm	10	10.5	15.5	20	27	34	36	39	46	56
r	21.4	23.5	23	29	37	39.5	45.5	53	62.8	66.5
t	CSF	2	2	2.4	2.8	3	5.5	6.1	5	6.8
	CSG	1.1	0.8	1	1.4	1.4	3.3	3.5	2.2	3.4
u	CSF	6	7	7.4	8.8	11	15.5	18.1	19	22.8
	CSG	5.1	5.8	6	7.4	9.4	13.3	15.5	16.2	19.4
øv	8	7	10	15	20	24	25	32	38	44
øy	14	18	21	26	26	32	32	32	40	48
Weight (Kg)	0.52	0.68	0.98	1.5	3.2	5.0	7.0	8.9	14.6	20.9

*U, V, W dimensions can be changed to accommodate a range of motor shaft diameters.

Specification for Cross Roller Bearing

Housed units incorporate a precise cross roller bearing to directly support a load. The inner race of the bearing forms the output flange.

Please calculate maximum load moment, life of cross roller bearing, and static safety factor to fully maximize the performance of housed unit (gearhead).

Calculation Procedure

1. Maximum Load Moment (Mmax)

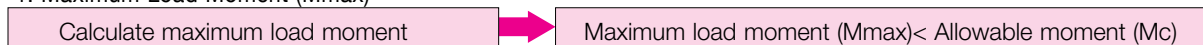

2. Output Bearing Life

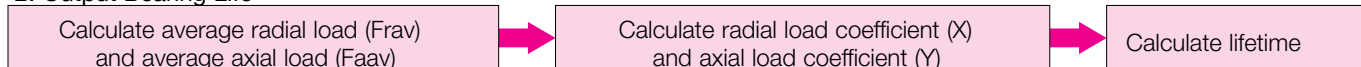

3. Static Safety Factor

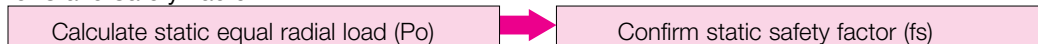

Specification for cross roller bearing

Specification for cross roller bearing is shown on figure.

Table 30

Size	Pitch Circle	Offset	Basic Dynamic Rated Load		Basic Static Rated Load		Allowable Moment Load Mc		Moment Rigidity Km	
	dp	R	C		Co				x10 ⁴	
	m	m	X10 ² N	lb	X10 ² N	lb	Nm	in-lb	Nm/rad	in-lb/arc-min
14	0.035	0.0095	47.4	1066	60.7	1365	41	363	4.38	113
17	0.0425	0.0095	52.9	1189	75.5	1697	64	566	7.75	200
20	0.050	0.0095	57.8	1299	90.0	2023	91	805	12.8	330
25	0.062	0.0115	96.0	2158	151	3395	156	1381	24.2	623
32	0.080	0.013	150	3372	250	5621	313	2770	53.9	1380
40	0.096	0.0145	213	4789	365	8206	450	3983	91.0	2340
45	0.111	0.0155	230	5171	426	9577	686	6071	141	3630
50	0.119	0.018	348	7824	602	13534	759	6717	171	4400
58	0.141	0.0205	518	11646	904	20324	1180	10443	283	7290
65	0.160	0.0225	556	12500	1030	23156	1860	16461	404	10400

Basic dynamic rated load is a constant radial load where the basic dynamic rated life of CRB is 1 x 10⁶ rotations.

Basic static rated load is a static load where the value of moment rigidity is the average value.

Output Bearing Ratings

How to Calculate the Maximum Load Moment

How to calculate the Maximum load moment is shown below. Please be sure that M_c is equal or greater than M_{max} .

$$M_{max} = F_{rmax} \cdot (L_r + R) + F_{amax} \cdot L_a$$

F_{rmax}	Max. radial load	N	Figure 7
F_{amax}	Max. axial load	N	Figure 7
L_r, L_a	Moment arm	m	Figure 6
R	amount of offset	m	Table 30

How to Calculate an Average Load

To calculate average radial load, average axial load or average output speed, follow steps below.

When the radial load and axial load vary, the life of cross roller bearing can be determined by converting to an average load. (see figure 7)

equation (11) Calculate Average Radial Load

$$F_{rav} = \sqrt[10/3]{\frac{n_1 t_1 |F_{r1}|^{10/3} + n_2 t_2 |F_{r2}|^{10/3} \dots + n_n t_n |F_{rn}|^{10/3}}{n_1 t_1 + n_2 t_2 \dots + n_n t_n}}$$

However Max. radial load in t_1 is F_{r1} , Max. radial load in t_3 is F_{r3} .

equation (12) Calculate Average Axial Load(F_{aav})

$$F_{aav} = \sqrt[10/3]{\frac{n_1 t_1 |F_{a1}|^{10/3} + n_2 t_2 |F_{a2}|^{10/3} \dots + n_n t_n |F_{an}|^{10/3}}{n_1 t_1 + n_2 t_2 \dots + n_n t_n}}$$

However, an axial load in t_1 is F_{a1} , Max. axial load in t_3 is F_{a3} .

equation (13) Calculate Average Output Speed

$$N_{av} = \frac{n_1 t_1 + n_2 t_2 \dots + n_n t_n}{t_1 t_2 \dots + t_n}$$

How to calculate radial load coefficient (X) axial load (Y)

		list 2	
	X	Y	
F_{aav}	≤ 1.5	1	0.45
$F_{rav} + 2 (F_{rav} (L_r + R) + F_{aav} \cdot L_a) / dp$			
F_{aav}	> 1.5	0.67	0.67
$F_{rav} + 2 (F_{rav} (L_r + R) + F_{aav} \cdot L_a) / dp$			

F_{rmax}	Max. radial load	N	Figure 7
F_{amax}	Max. axial load	N	Figure 7
L_r, L_a	Moment arm	m	Figure 6
R	amount of offset	m	Table 30
dp	pitch circle	m	Table 30

Figure 6

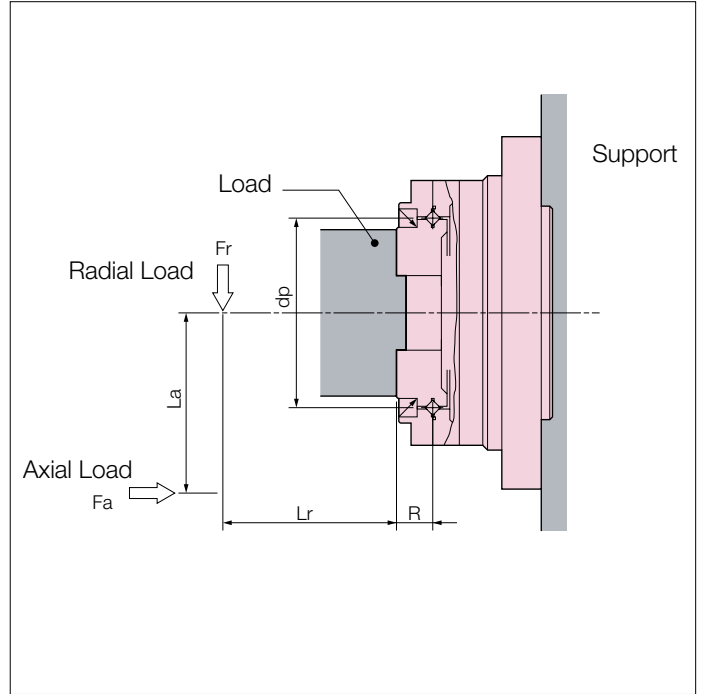
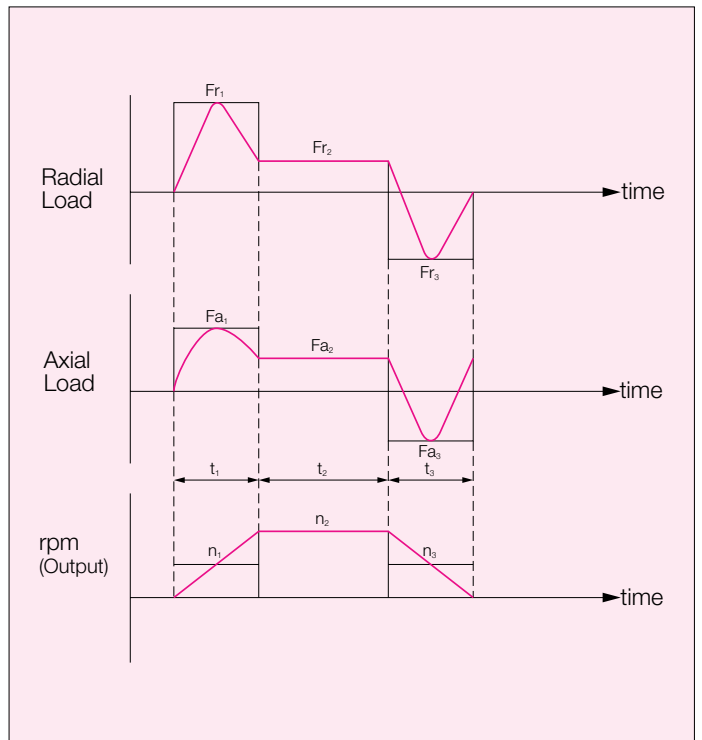

Figure 7



How to Calculate Life of the Output Bearing

The life of a cross roller bearing can be calculated by equation (15).
equation (15)

$$L_{10} = \frac{10^6}{60 \times N_{av}} \times \left(\frac{C}{f_w \cdot P_c} \right)^{10/3}$$

Equation 15

L_{10}	Life	Hour	-----
N_{av}	Average Output Speed	rpm	equation 13
C	Basic Dynamic Rated Load	N	table 30
P_c	Dynamic Equivalent	N	equation 16
f_w	Load Coefficient	-----	list 3

List 3

Load Coefficient, f_w	
Steady operation without impact and vibration	1~1.2
Normal operation	1.2~1.5
Operation with impact and vibration	1.5~3

Dynamic Equivalent Radial Load

equation 16

$$P_c = X \cdot \left(\frac{2 (F_{rav} (L_r + R) + F_{aav} \cdot L_a)}{d_p} \right) + Y \cdot F_{aav}$$

Symbol of equation

F_{rav}	Average radial load	N	equation 11
F_{aav}	Average axial load	N	equation 12
d_p	Pitch diameter	m	table 30
X	Radial load coefficient	-----	list 2
Y	Axial load coefficient	-----	list 2
L_r, L_a	Moment Arm	m	figure 6
R	Offset	m	figure 6 and table 30

How to Calculate Static Safety Coefficient

Basic static rated load is an allowable limit for static load, but its limit is determined by usage. In this case, static safety coefficient of the cross roller bearing can be calculated by equation 17. Reference values under general conditions are shown on list 4. Static equivalent radial load can be calculated by equation (17)
equation (17)

$$f_s = \frac{C_o}{P_o}$$

Symbols for equation (17)

C_o	Basic static rated load	N	table 30
P_o	Static equivalent radial load	N	refer to equation (19)

list 4

Rotating Conditions	Load Conditions	Lower Limit Value for f_s
Normally not rotating	Slight oscillations Impact loads	0.5 1-1.5
Normally rotating	Normal loads Impact loads	1-2 2-3

How to Calculate Life for Oscillating Motion

The Life of a cross roller bearing in a oscillating operation can be calculated by equation 18

equation (18)

$$L_{oc} = \frac{10^6}{60 \times n_1} \times \frac{90}{\theta} \times \left(\frac{C}{f_w \cdot P_c} \right)^{10/3}$$

Symbol of equation

L_{oc}	Rated life for oscillating motion	Hour	-----
n_1	Round trip oscillation each minute	rpm	-----
C	Basic dynamic rated load	N	-----
P_c	Dynamic equivalent radial load	N	equation 16
f_w	Load Coefficient	-----	list 3
θ	Angle of oscillation/2	degrees refer to figure	

figure 8

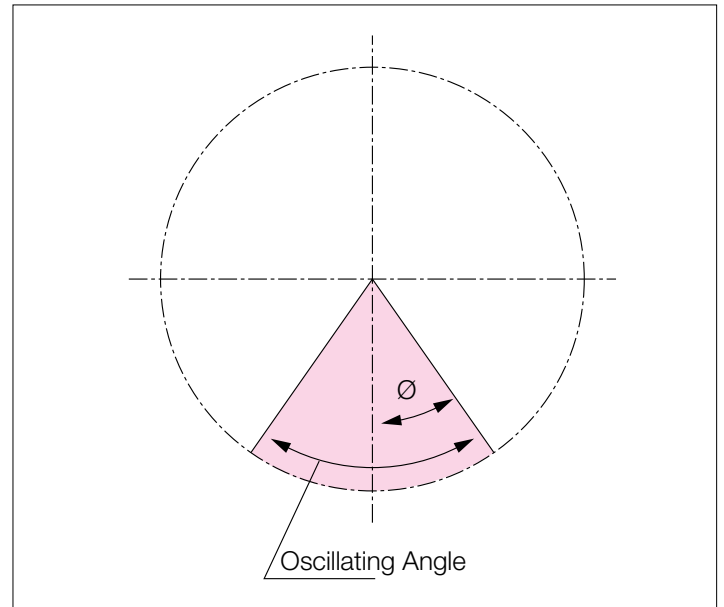

A small angle of oscillation (less than 5 degrees) may cause fretting corrosion to occur since lubrication may not circulate properly.

equation (19)

$$P_o = F_{rmax} + \frac{2M_{max}}{d_p} + 0.44 \cdot F_{amax}$$

Symbols for Equation (19)

F_{rmax}	Max. radial load	N
F_{amax}	Max. axial load	N
M_{max}	Max. moment load	Nm
d_p	Pitch diameter	m

Recommended Tolerances for Assembly

Installation accuracy

For optimum performance of the CSF-2UH unit, please maintain the recommended tolerances shown in figure.

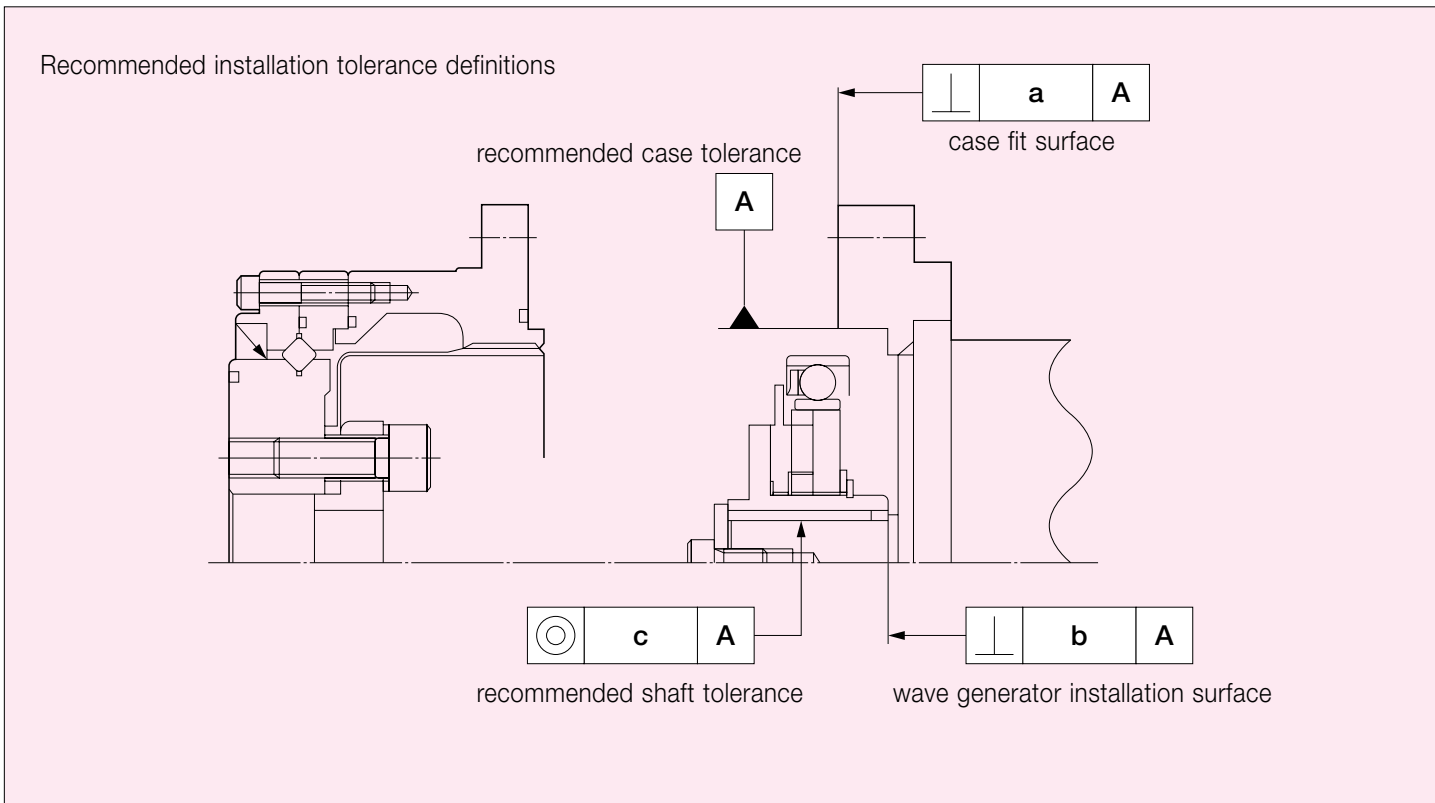

Recommended installation tolerances (mm)

Table 31

	14	17	20	25	32	40	45	50	58	65
a	0.011	0.015	0.017	0.024	0.026	0.026	0.027	0.028	0.031	0.034
b	0.017 (0.008)	0.020 (0.010)	0.020 (0.010)	0.024 (0.012)	0.024 (0.012)	0.032 (0.012)	0.032 (0.013)	0.032 (0.015)	0.032 (0.015)	0.032 (0.015)
c	0.030 (0.016)	0.034 (0.018)	0.044 (0.019)	0.047 (0.022)	0.050 (0.022)	0.063 (0.024)	0.065 (0.027)	0.066 (0.030)	0.068 (0.033)	0.070 (0.035)

The values in parentheses indicate that the wave generator does not have an oldham coupling.

Installation and transmission torque

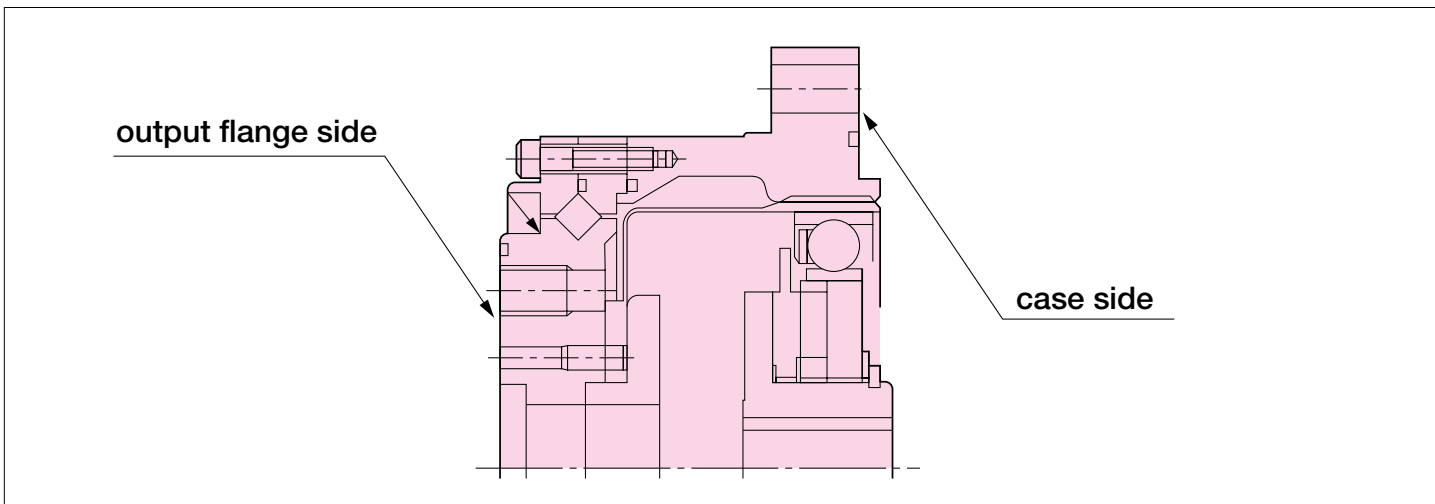

Installation on Output Flange Side and Resulting Transmission Torque

Table 32

Size		14	17	20	25	32	40	45	50	58	65
number of screws		6	6	8	8	8	8	8	8	8	8
size of screws		M4	M5	M6	M8	M10	M10	M12	M14	M16	M16
pitch circle diameter	mm	23	27	32	42	55	68	82	84	100	110
clamp torque/screw	Nm	5.4	10.8	18.4	45	89	89	128	205	319	319
torque transmitting capacity	Nm	58	109	245	580	1220	1510	2200	3070	4980	5480

Installation on Case Side and Resulting Transmission Torque

Table 33

Size		14	17	20	25	32	40	45	50	58	65
number of screws		6	6	6	8	12	8	12	12	12	8
size of screws		M4	M4	M5	M5	M6	M8	M8	M8	M10	M12
pitch circle diameter	mm	65	71	82	96	125	144	164	174	206	236
clamp torque/screw	Nm	4.5	4.5	9.0	9.0	15.3	37	37	37	74	128
torque transmitting capacity	Nm	137	147	274	431	1200	1680	2860	3040	5670	6310

1. The material of the thread must withstand the clamp torque.
2. Recommended bolt : JIS B 1176 socket head cap screw strength range : JIS B 1051 over 12.9
3. Torque coefficient : $K=0.2$
4. Clamp coefficient $A=1.4$
5. Friction coefficient on the surface contacted: 0.15
6. Dowel Pin: parallel pin Material:S45C-Q Shear stress:~+30kgf/m

Lubrication

The standard lubrication for the Harmonic Drive™ gear is Harmonic Grease SK-1A and SK-2.
(Harmonic grease 4B No.2 is used for cross roller bearing.)
Please see page 23 for grease specification.

Seal Structure

A seal structure is needed to maintain the high durability of the gear and prevent grease leakage.

Key Points to Verify

- Rotating parts should have an oil seal (with spring)
- Surface should be smooth (no scratches)
- Mating flanges should have an O Ring, seal adhesive
- Screws should have a thread lock
(Loctite 242 recommended) or seal adhesive.

(note)

If you use Harmonic Grease 4BNo.2, strict sealing is required.

Sealing Recommendations for Housed Units

Output Side	Holes which penetrate housing	O ring (supplied by Harmonic Drive LLC)
	Installation screw / bolt	Screw lock adhesive which has effective seal (recommendation: Loctite 242)
Input Side	Flange surfaces	Use o-ring (supplied by Harmonic Drive LLC)
	Motor output shaft	Please select a motor which has an oil seal on the output shaft.

Efficiency

Efficiency

The efficiency depends on the conditions shown below.
 Efficiency depends on gear ratio, input speed, load torque, temperature, quantity of lubricant and type of lubricant.
 Efficiency values shown are for rated torque. If load torque is below rated torque, a compensation factor must be employed.

Load Torque \geq Rated Torque : Efficiency = Efficiency from Graph

Load Torque $<$ Rated Torque : Efficiency = Efficiency from Graph x Compensation Coefficient from figure 9.

Measurement Condition

Installation : Based on recommended tolerance
 Load torque : Rated torque
 Lubricant : Harmonic Grease SK-1A
 Harmonic Grease SK-2
 Harmonic Grease 4B No.2
 Grease quantity : Recommended quantity

Please contact us for details pertaining to recommended oil lubricant.

COMPONENT SET 8,11, 14

Harmonic Drive Grease SK-2

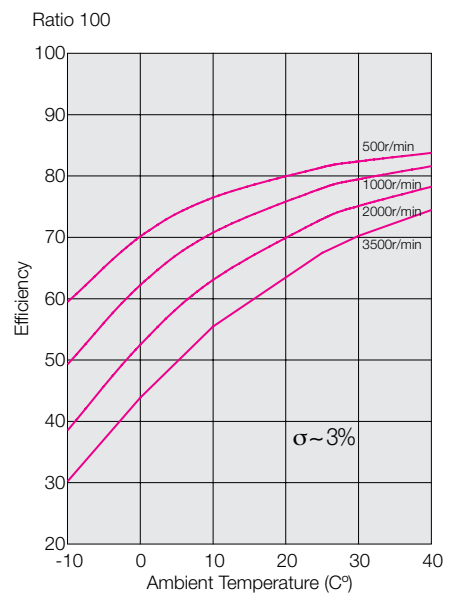
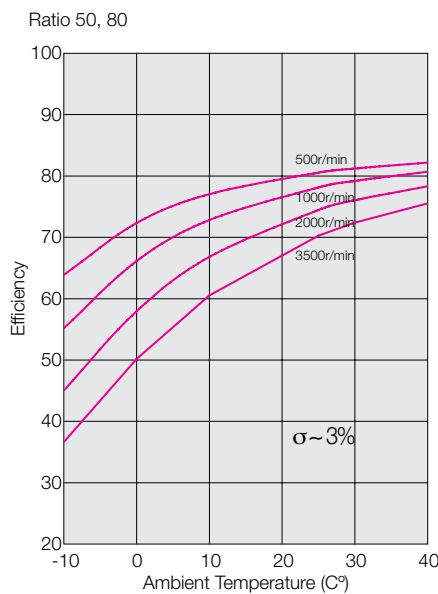
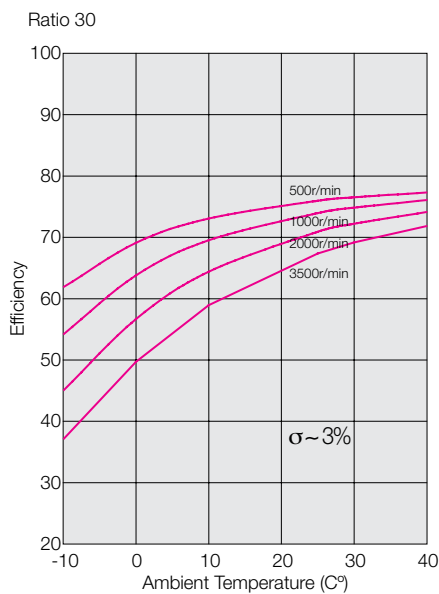

Harmonic Drive Grease 4B No.2A

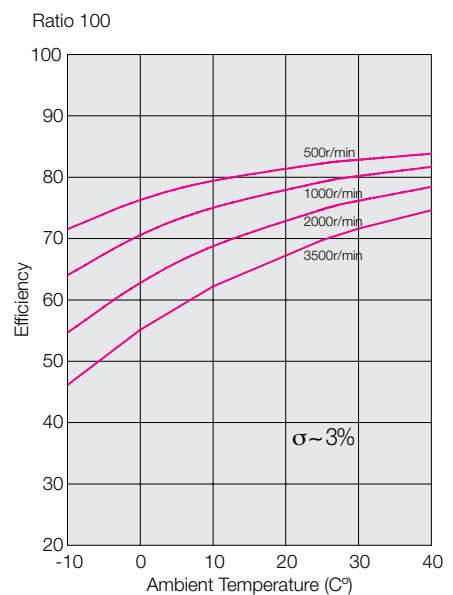
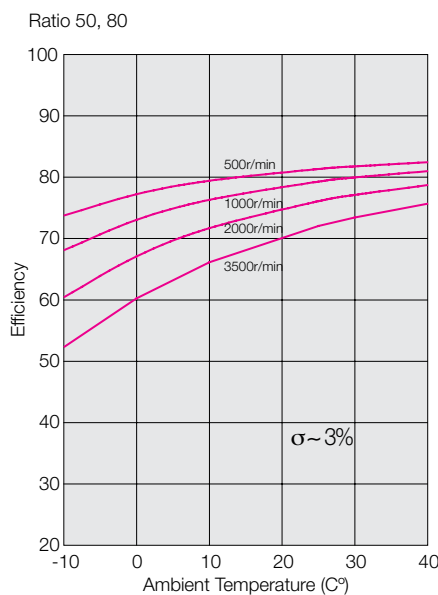
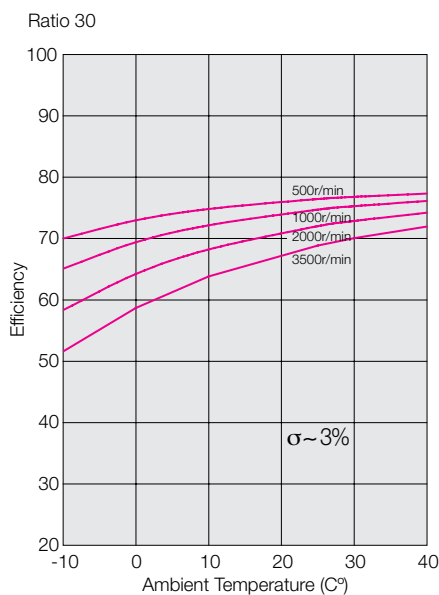
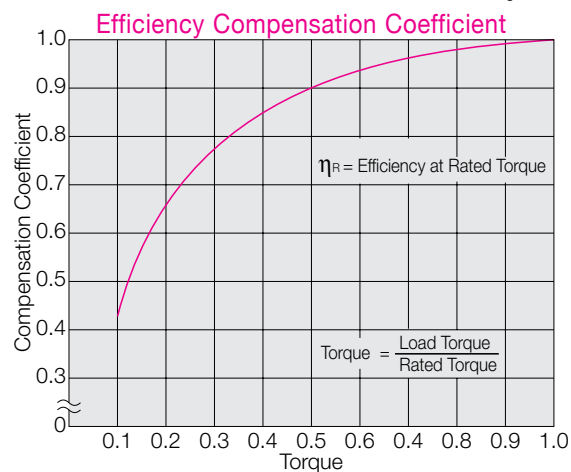
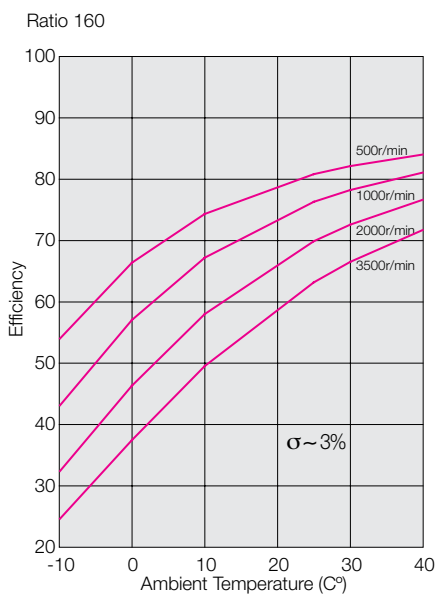
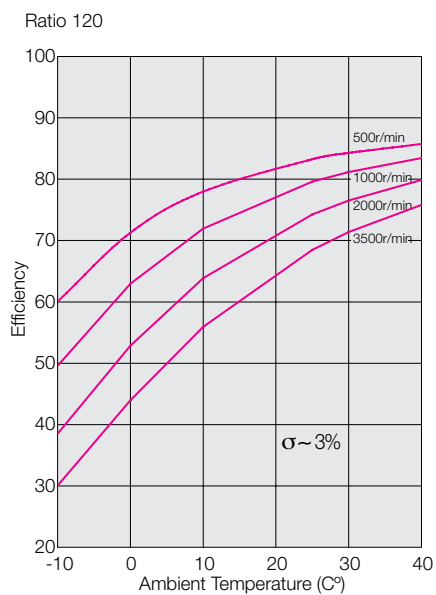
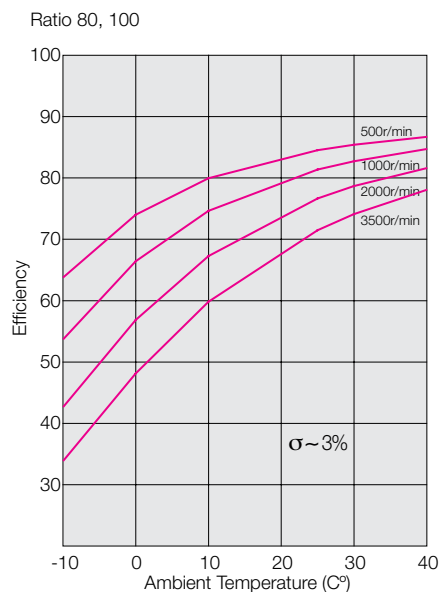
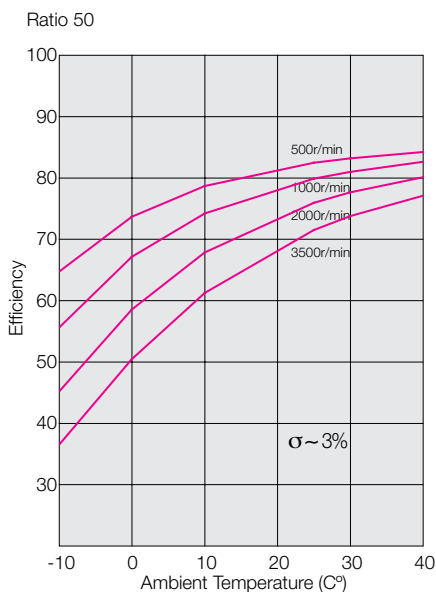
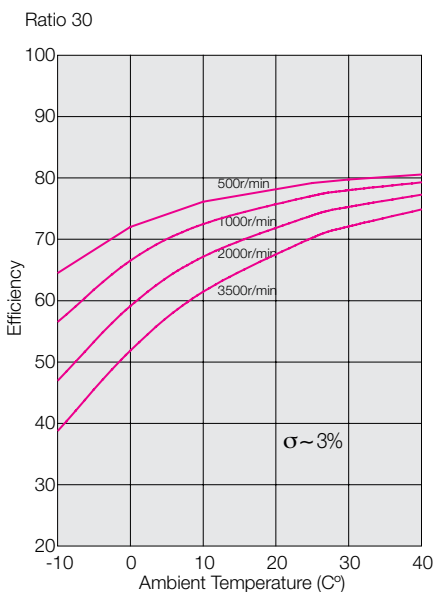

Figure 9



COMPONENT SET 17~100

Harmonic Drive Grease SK-1A, SK-2



COMPONENT SET 17~100

Harmonic Drive Grease 4B No.2

Ratio 30

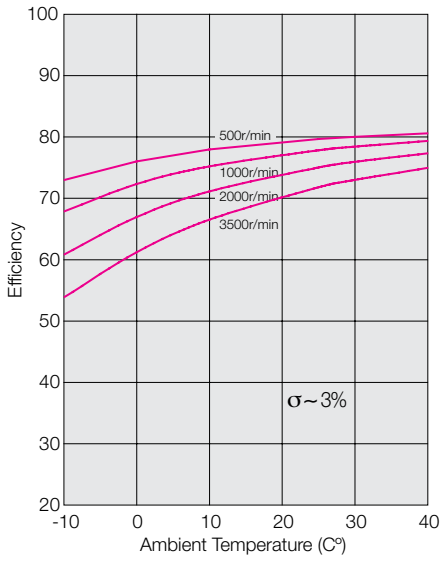

Ratio 50

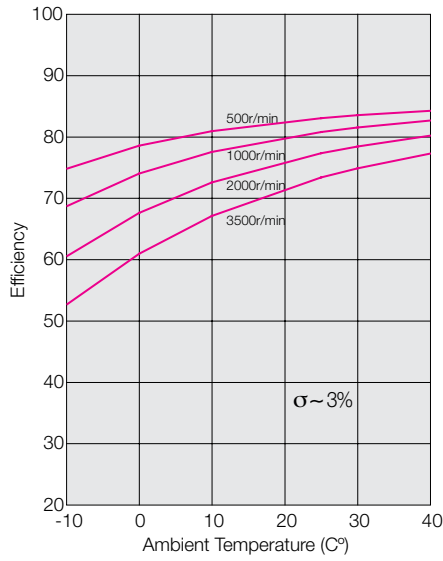

Ratio 80, 100

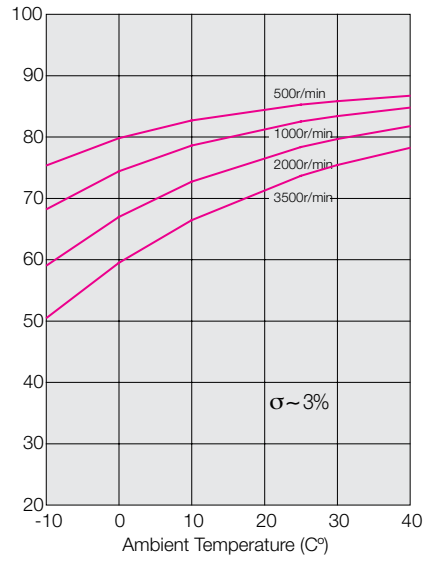

Ratio 120

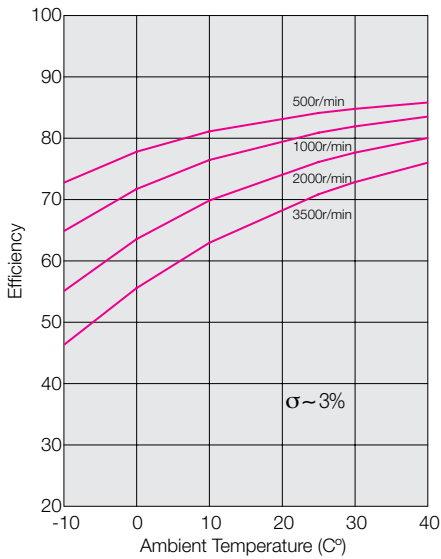

Ratio 160

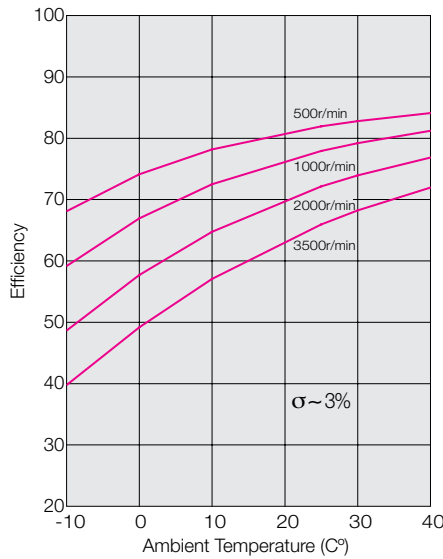

HOUSED UNIT 14

Harmonic Drive Grease SK-2

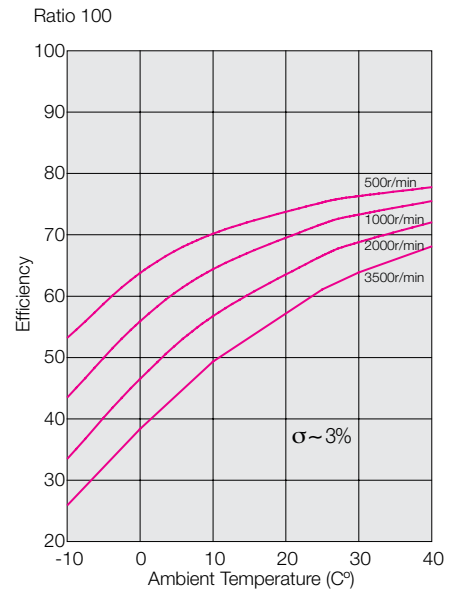
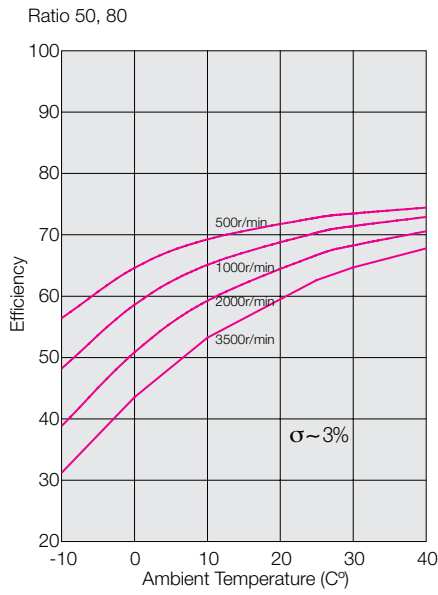
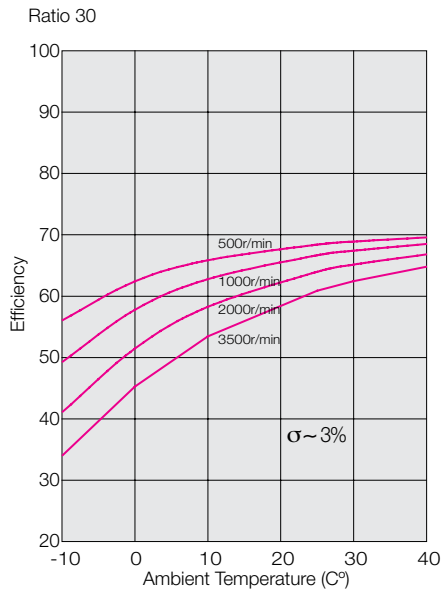

Harmonic Drive Grease 4B No.2A

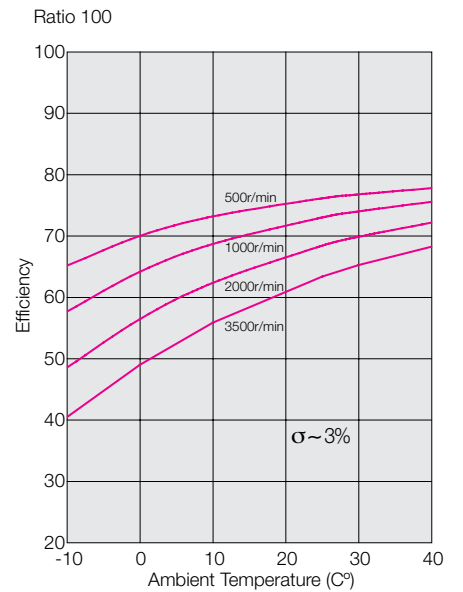
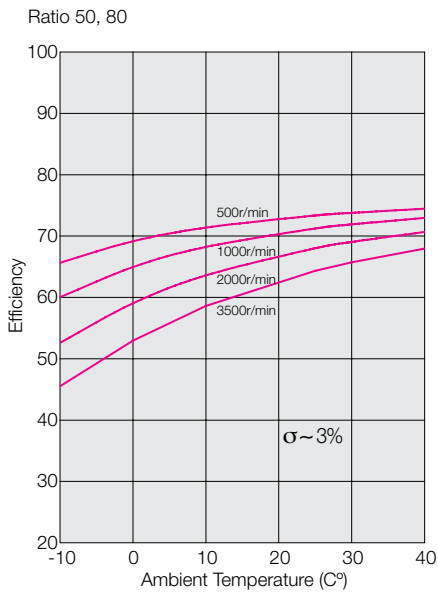
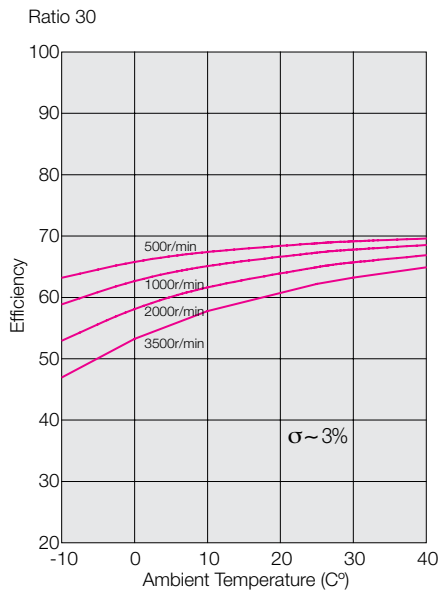

HOUSED UNIT 17~65

Harmonic Drive Grease SK-1A, SK-2

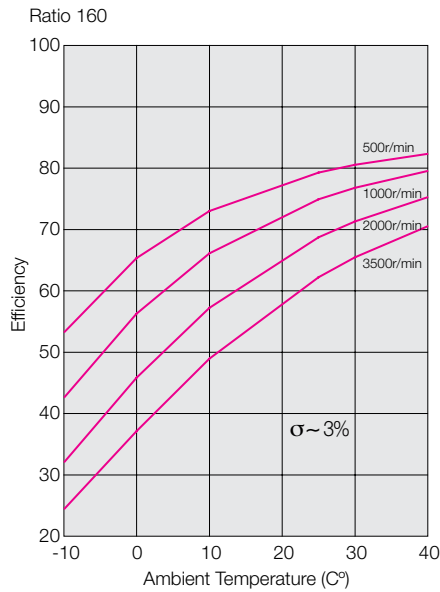
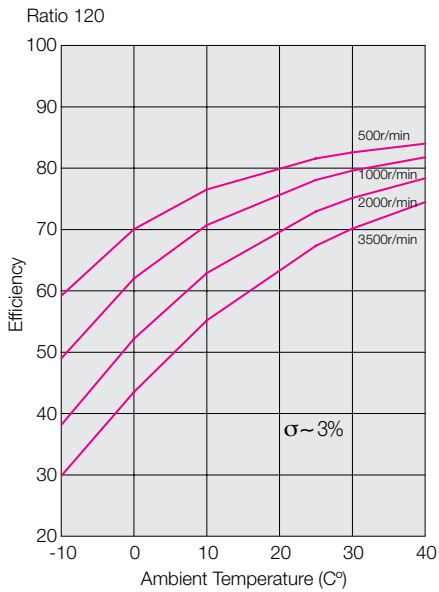
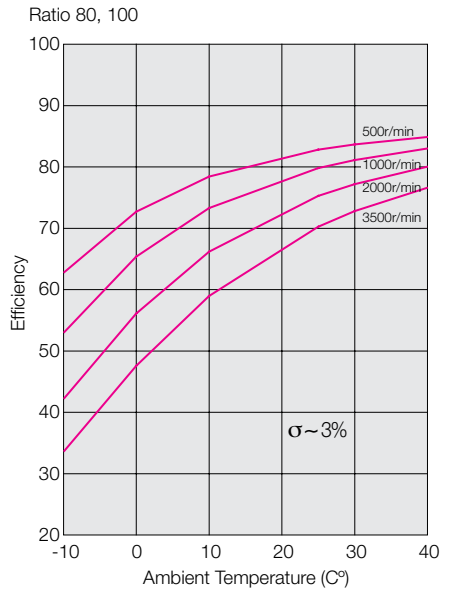
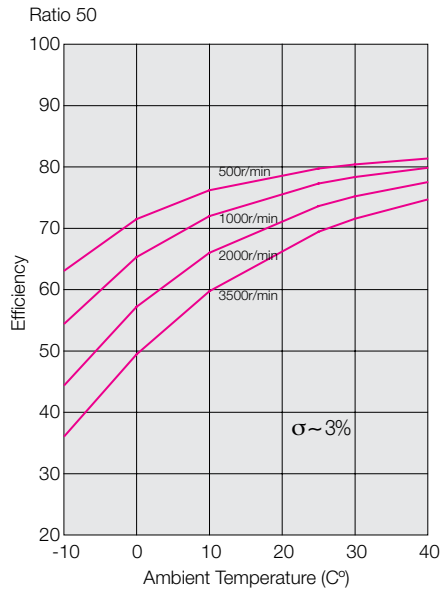
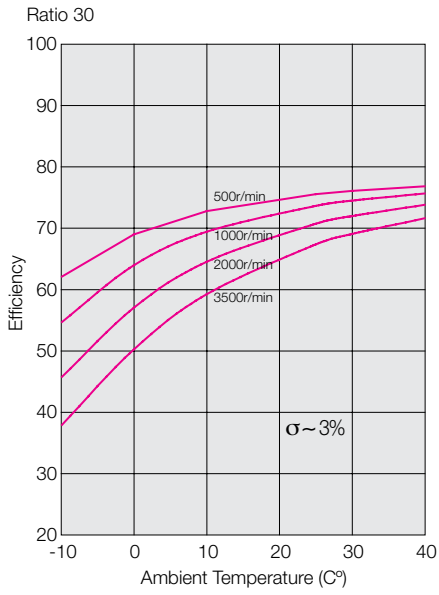

HOUSED UNIT 17~65

Harmonic Drive Grease 4B No.2

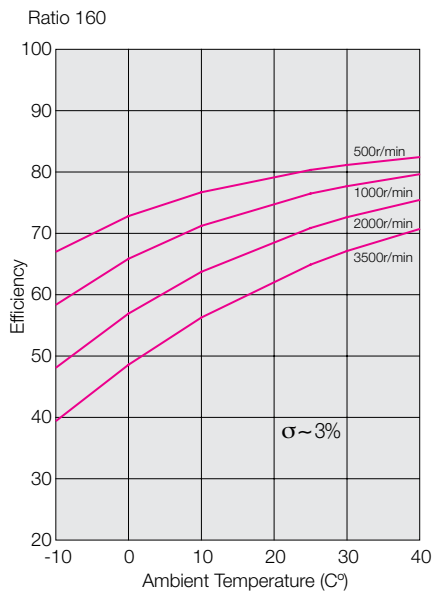
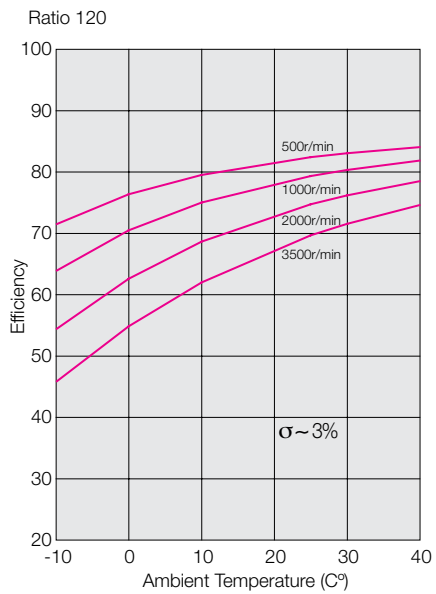
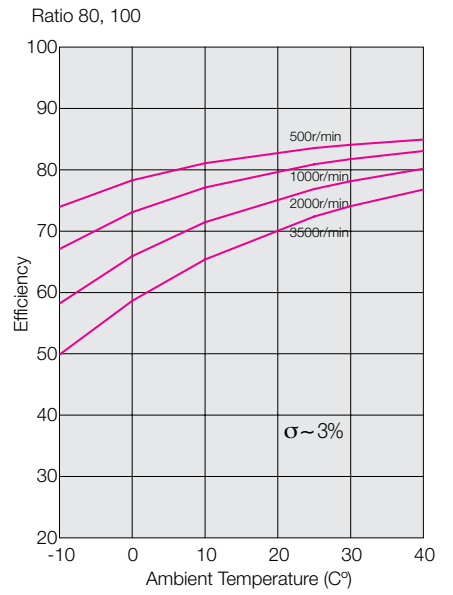
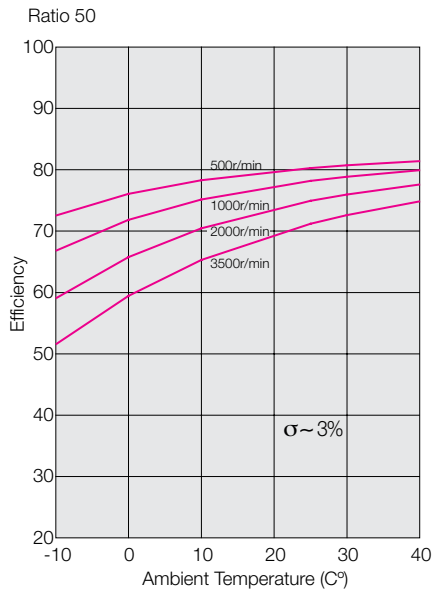
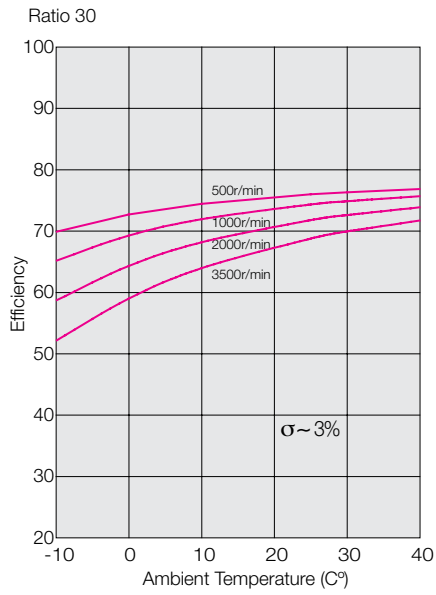

No Load Running Torque

No Load Running Torque

No load running torque indicates the torque which is needed to rotate input of the gear, "Wave Generator", with no load on the output side (low speed side). Please contact us regarding details.

Measurement condition

Ratio : 1/100

Lubricant : Harmonic Grease SK-1A

Harmonic Grease SK-2

Harmonic Grease 4BNo.2

Quantity : Recommended quantity

see page 19

Torque value is measured after 2 hours at 2000rpm input.

In case of oil lubricant, please contact us.

COMPONENT SET

Harmonic Drive Grease SK-1A , SK-2

Input Speed 500r/min

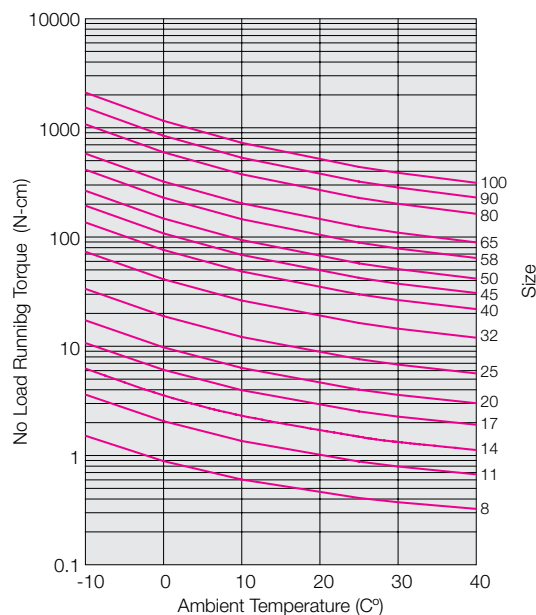

Input Speed 1000r/min

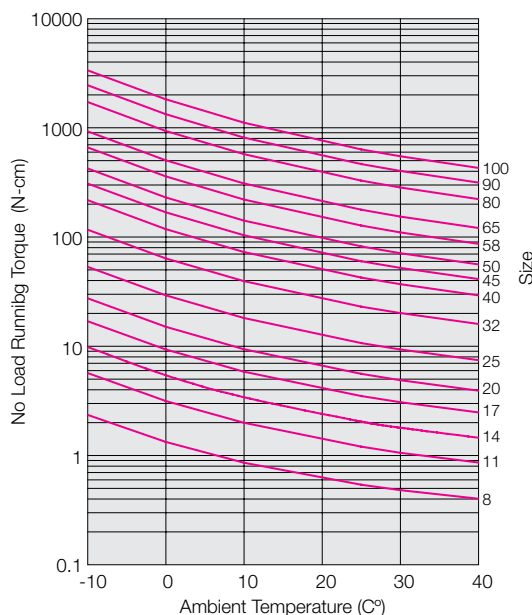

Input Speed 2000r/min

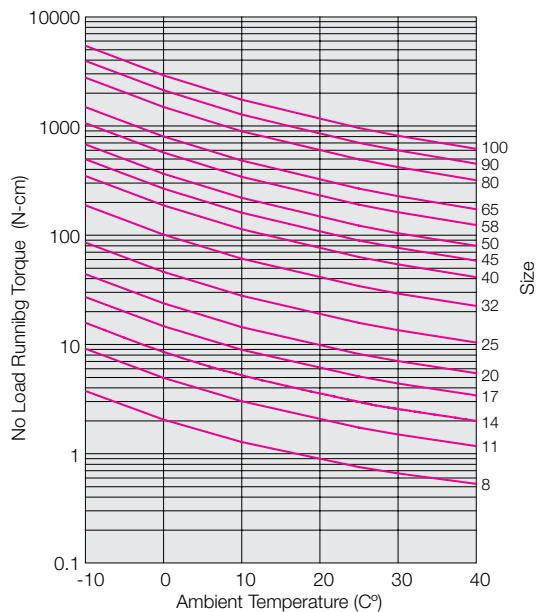

Input Speed 3500r/min

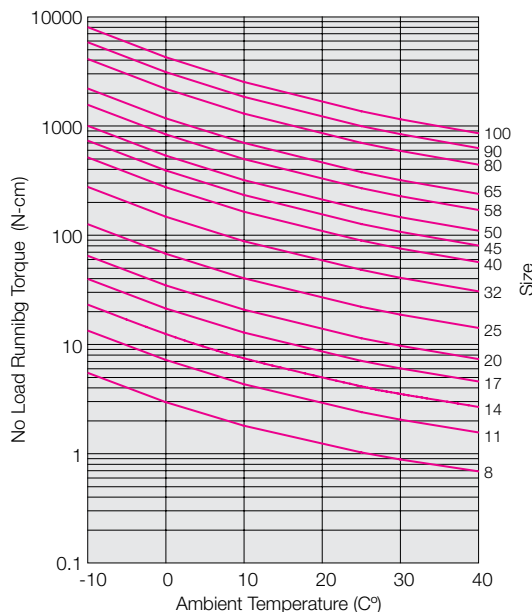

Compensation Value in Each Ratio (Component Set)

No load running torque of the gear varies with ratio. The graphs indicate a value for ratio 100. For other gear ratios, add the compensation values from table 34.

Component Set	No Load Running Torque Compensation Value					Ncm	Table 34
size / ratio	30	50	80	120	160		
8	0.4	0.2	-	-	-		
11	0.7	0.3	-	-	-		
14	1.1	0.5	0.1	-	-		
17	1.8	0.8	0.1	-0.1	-		
20	2.7	1.2	0.2	-0.1	-0.3		
25	5.0	2.2	0.3	-0.2	-0.6		
32	10	4.5	0.7	-0.5	-1.2		
40	-	8.0	1.2	-0.9	-2.2		
45	-	11	1.7	-1.3	-3.0		
50	-	15	2.3	-1.7	-4.0		
58	-	22	3.4	-2.5	-6.1		
65	-	31	4.7	-3.5	-8.4		
80	-	55	8.5	-6.2	-15		
90	-	77	12	-8.7	-21		
100	-	100	16	-12	-28		

COMPONENT SET

Harmonic Drive Grease 4B No.2

Input Speed 500r/min

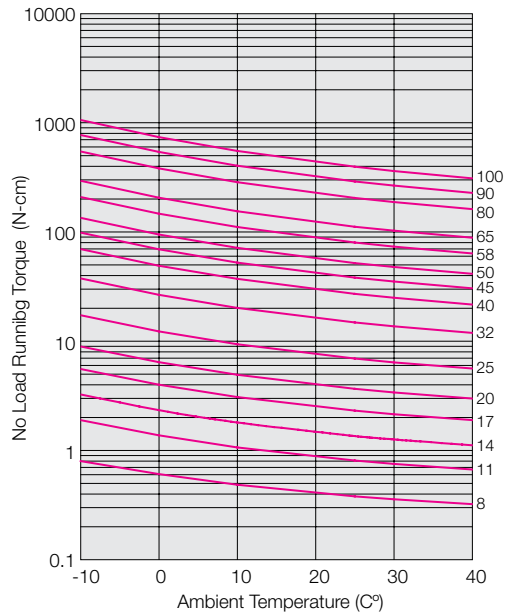

Input Speed 1000r/min

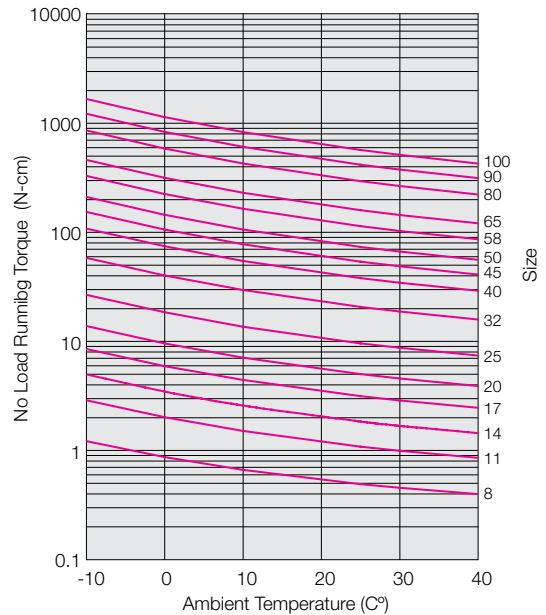

Input Speed 2000r/min

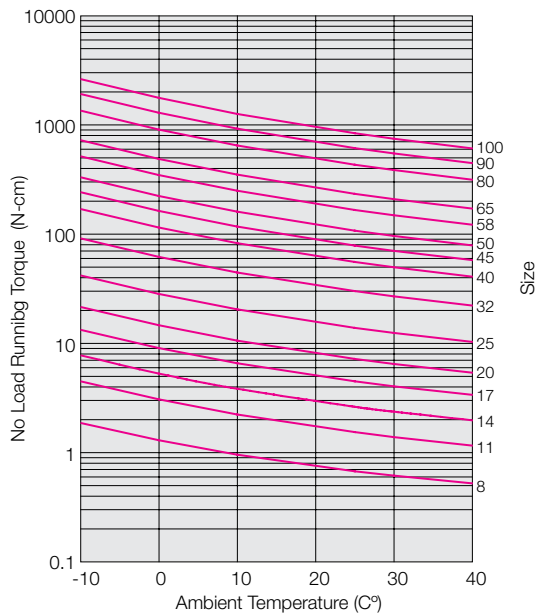

Input Speed 3500r/min

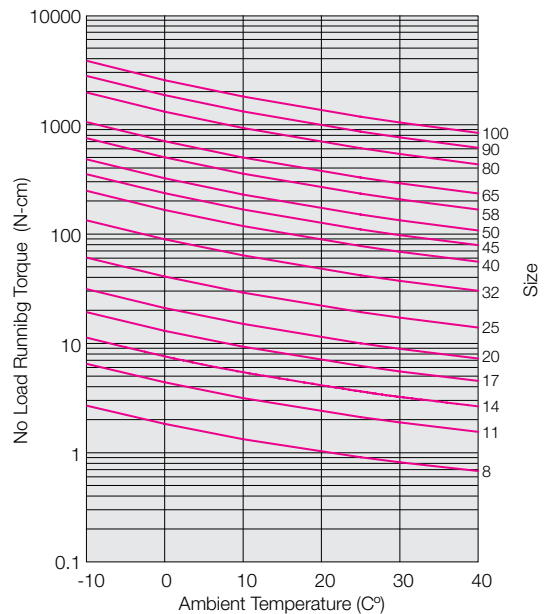

No Load Running Torque

Compensation Value in Each Ratio (unit type)

No load running torque of the gear varies with ratio. The graphs indicate a value for ratio 100. For other gear ratios, add the compensation values from table 35.

Unit type, compensation amount of no load, running torque compensation value. Ncm Table 35

size / ratio	30	50	80	120	160
14	2.5	1.1	0.2	-	-
17	3.8	1.6	0.3	-0.2	-
20	5.4	2.3	0.5	-0.3	-0.8
25	8.8	3.8	0.7	-0.5	-1.2
32	16	7.1	1.3	-0.9	-2.2
40	-	12	2.1	-1.5	-3.5
45	-	16	2.9	-2.1	-4.9
50	-	21	3.7	-2.6	-6.2
58	-	30	5.3	-3.8	-8.9
65	-	41	7.2	-5.1	-12

HOUSED UNIT

Harmonic Drive Grease SK-1A, SK-2

Input Speed 500r/min

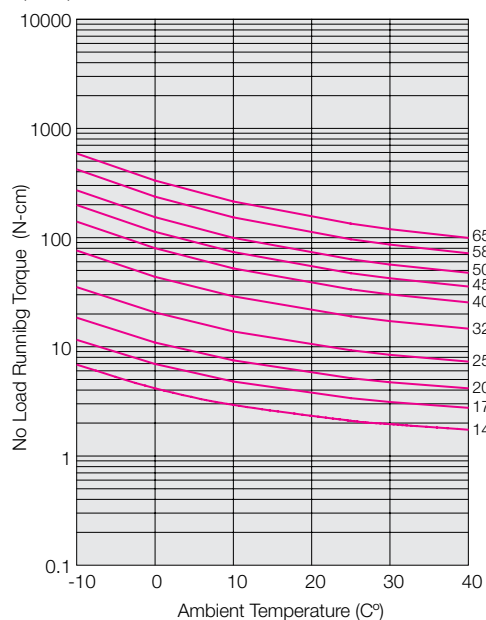

Input Speed 1000r/min

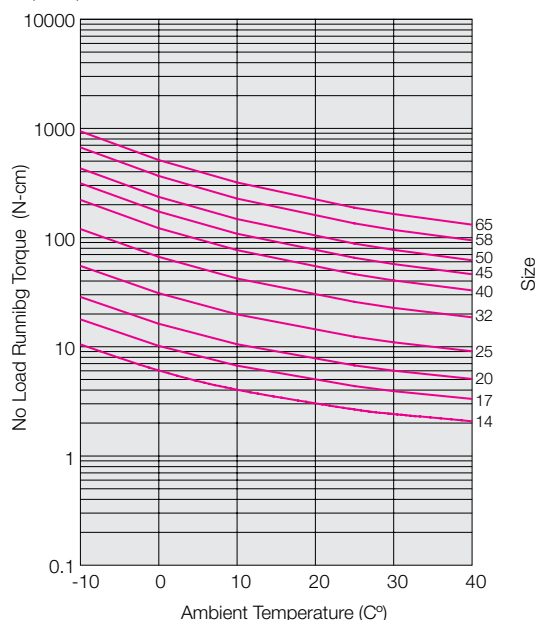

Input Speed 2000r/min

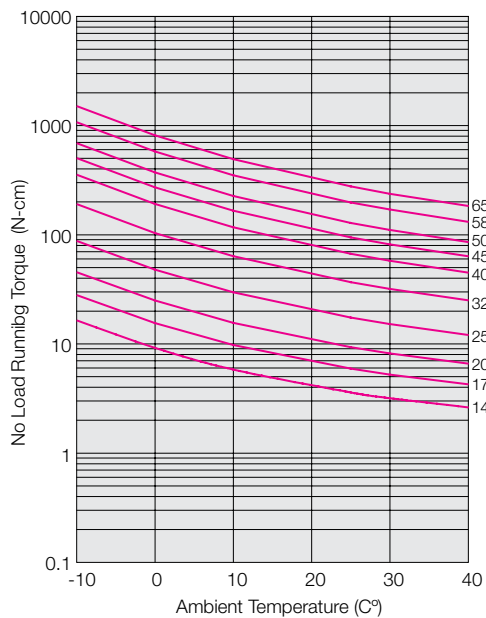

Input Speed 3500r/min

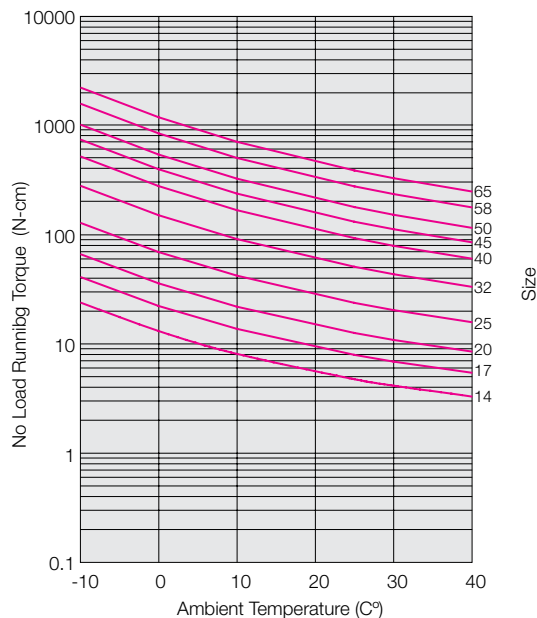

HOUSED UNIT

Harmonic Drive Grease 4B No.2

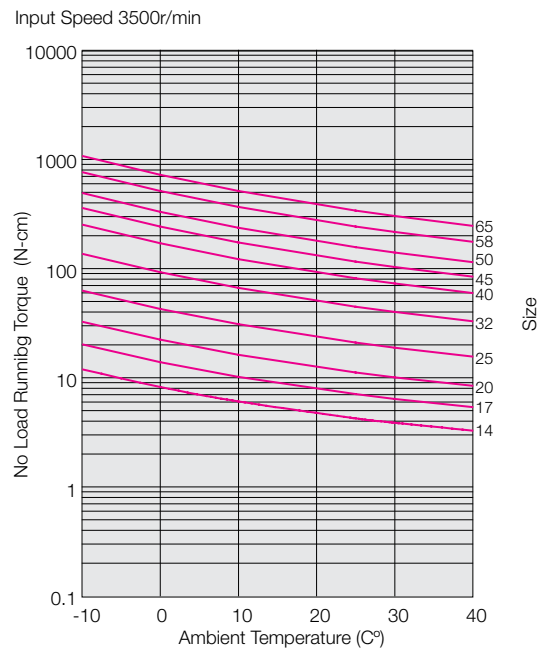
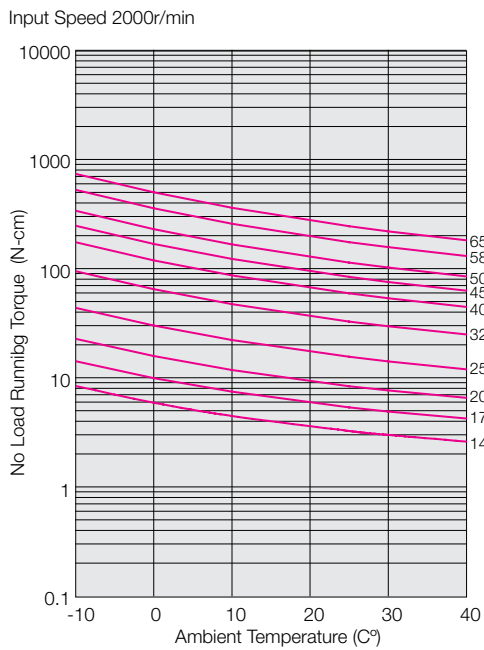
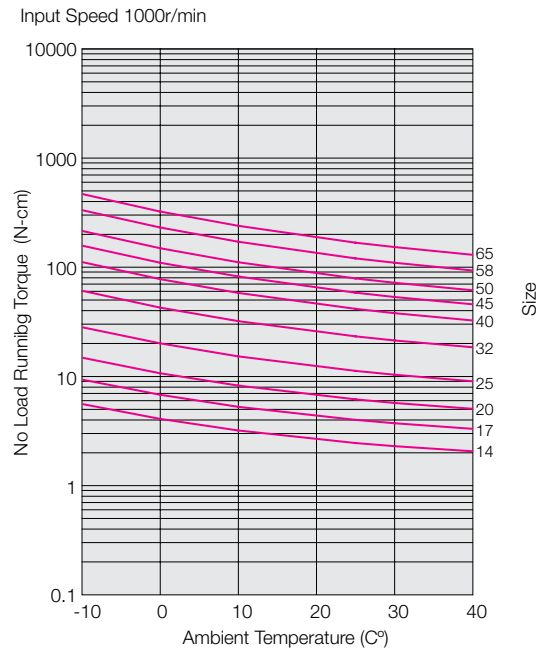
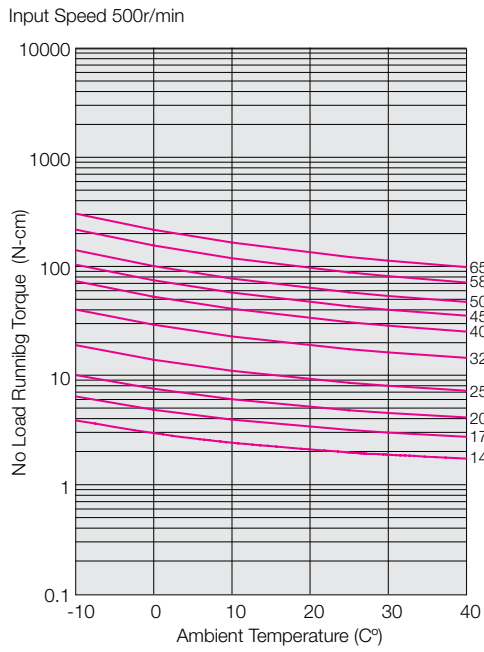

Starting Torque

Starting torque is the torque required to commence rotation of the input element (high speed side), with no load being applied to the output. The table below indicates the maximum values. The lower values are approximately 1/2 to 1/3 of the maximum values.

Component Type Backdriving Torque

Backdriving torque is the torque required to commence rotation of input element (high speed side) when torque is applied on the output side (low speed side). The table below indicates the maximum values. The typical values are approximately 1/2 to 1/3 of the maximum values. The backdriving torque should not be relied upon to provide a holding torque to prevent the output from backdriving. A failsafe brake should be used for this purpose.

Measurement condition: Ambient temperature 20°C

Values shown below vary depending on condition. Please use values as a reference.

Starting Torque for Component Sets (Ncm)

Table 36

Size		8	11	14	17	20	25	32	40	45	50	58	65	80	90	100
30	CSF	1.3	2.7	4.3	6.5	11	19	45	-	-	-	-	-	-	-	-
	CSG	-	-	4.7	7.2	12	21	50	-	-	-	-	-	-	-	-
50	CSF	0.8	1.6	3.3	5.1	6.6	12	26	46	63	86	130	180	320	450	590
	CSG	-	-	3.6	5.6	7.3	13	29	51	-	-	-	-	-	-	-
80	CSF	-	-	2.4	3.3	4.1	7.7	16	29	41	54	82	110	200	280	380
	CSG	-	-	2.6	3.6	4.5	8.5	18	32	-	-	-	-	-	-	-
100	CSF	0.59	1.1	2.1	2.9	3.7	6.9	15	26	36	48	73	98	180	250	340
	CSG	-	-	2.3	3.2	4.1	7.6	17	29	-	-	-	-	-	-	-
120	CSF	-	-	-	2.7	3.3	6.3	13	24	33	45	67	92	170	230	310
	CSG	-	-	-	3.0	3.6	6.9	14	26	-	-	-	-	-	-	-
160	CSF	-	-	-	-	2.9	5.5	12	21	29	39	58	80	140	200	270
	CSG	-	-	-	-	3.2	6.1	13	23	-	-	-	-	-	-	-

Back Driving Torque for Component Sets (Nm)

Table 37

Size		8	11	14	17	20	25	32	40	45	50	58	65	80	90	100
30	CSF	0.65	1.3	2	3.2	5.5	10	21	-	-	-	-	-	-	-	-
	CSG	-	-	2.2	3.5	6.1	11	23	-	-	-	-	-	-	-	-
50	CSF	0.5	1	1.4	2.5	4	7.5	16	28	37	52	80	110	200	270	360
	CSG	-	-	1.5	2.8	4.4	8.3	18	31	-	-	-	-	-	-	-
80	CSF	-	-	1.4	2.5	4.2	7.7	16	28	39	53	81	120	200	270	370
	CSG	-	-	1.5	2.8	4.6	8.5	18	31	-	-	-	-	-	-	-
100	CSF	0.7	1.4	1.7	2.8	4.5	8.4	18	31	42	57	88	130	220	300	400
	CSG	-	-	1.9	3.1	5.0	9.2	20	34	-	-	-	-	-	-	-
120	CSF	-	-	-	3.1	4.9	9.2	19	34	47	63	97	140	240	330	440
	CSG	-	-	-	3.4	5.4	10	21	37	-	-	-	-	-	-	-
160	CSF	-	-	-	-	5.8	11	23	40	57	77	120	170	290	390	540
	CSG	-	-	-	-	6.4	12	25	44	-	-	-	-	-	-	-

Starting Torque for Housed Units (Ncm)

Table 38

Size		14	17	20	25	32	40	45	50	58	65
30	CSF	6.4	9.3	15	25	54	-	-	-	-	-
	CSG	7.0	10	17	28	59	-	-	-	-	-
50	CSF	4.1	6.1	7.8	15	31	55	77	110	160	220
	CSG	4.5	6.7	8.6	17	34	61	-	-	-	-
80	CSF	2.8	4	4.9	9.2	19	35	49	66	98	140
	CSG	3.1	4.4	5.4	10	21	39	-	-	-	-
100	CSF	2.5	3.4	4.3	8	18	31	43	58	88	120
	CSG	2.8	3.7	4.7	8.8	20	34	-	-	-	-
120	CSF	-	3.1	3.8	7.3	15	28	39	52	80	110
	CSG	-	3.4	4.2	8.0	17	31	-	-	-	-
160	CSF	-	-	3.3	6.3	14	24	33	45	68	93
	CSG	-	-	3.6	6.9	15	26	-	-	-	-

Back driving Torque for Housed Units (Nm)

Table 39

Size		14	17	20	25	32	40	45	50	58	65
30	CSF	2.4	3.8	6.2	11	23	-	-	-	-	-
	CSG	2.6	4.2	6.8	12	25	-	-	-	-	-
50	CSF	1.6	3	4.7	9	18	33	47	62	95	130
	CSG	1.8	3.3	5.2	9.9	20	36	-	-	-	-
80	CSF	1.6	3	4.8	9.1	19	33	48	63	96	140
	CSG	1.8	3.3	5.3	10	21	36	-	-	-	-
100	CSF	1.8	3.3	5.1	9.8	20	36	51	68	110	150
	CSG	2	3.6	5.6	11	22	40	-	-	-	-
120	CSF	-	3.5	5.5	11	22	39	55	73	110	160
	CSG	-	3.9	6.1	12	24	43	-	-	-	-
160	CSF	-	-	6.4	13	26	46	64	85	130	180
	CSG	-	-	7	14	29	51	-	-	-	-

Positioning Accuracy

The positioning accuracy of the gear represents a linearity error between the input and output angle. The position error is the difference between theoretical and actual output rotation angle.

The positioning accuracy is measured for one complete output revolution using a high resolution measurement system. The measurements are carried out without reversing direction.

The positioning accuracy is defined as the difference between the maximum positive and maximum negative deviation from the theoretical position.

Typical Positional Accuracy Curve

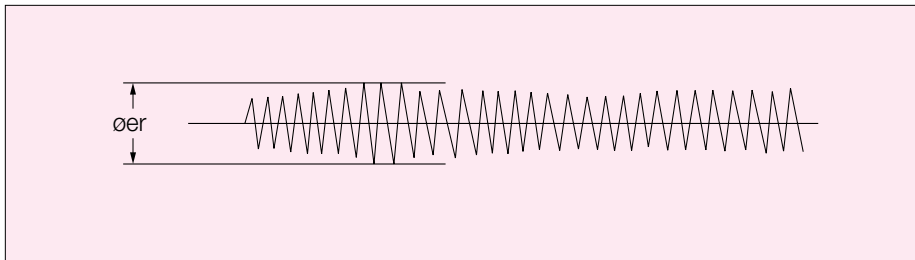

Position Accuracy

$\times 10^{-4}$ rad (arc-min)

Table 40

Gear Ratio		8	11	14	17	20	25	32	40-100
30	standard	5.8 (2)	5.8 (2)	5.8 (2)	4.4 (1.5)	4.4 (1.5)	4.4 (1.5)	4.4 (1.5)	- -
	special	- -	- -	- -	- -	2.9 (1)	2.9 (1)	2.9 (1)	- -
50 and larger	standard	5.8 (2)	4.4 (1.5)	4.4 (1.5)	4.4 (1.5)	2.9 (1)	2.9 (1)	2.9 (1)	2.9 (1)
	special	--- -	- -	(1) (1)	(1) (1)	1.5 (0.5)	1.5 (0.5)	1.5 (0.5)	1.5 (0.5)

Torsional Stiffness

Torsional stiffness is determined by applying a load to the output of the gear, with the input rotationally locked. The angular rotation is measured as the load is increased. The typical curve (shown in the figure 11) is non-linear. The stiffness is determined the slope of this curve. For simplicity, the curve is approximated by 3 straight lines having stiffness of K_1 , K_2 , and K_3 . Stiffness K_1 applies for output torque of 0 to T_1 . Stiffness K_3 applies for output torque greater than T_2 . Stiffness K_2 applies for output torque between T_1 and T_2 . Typical stiffness values are shown in tables 41, 42, 43.

Figure 10

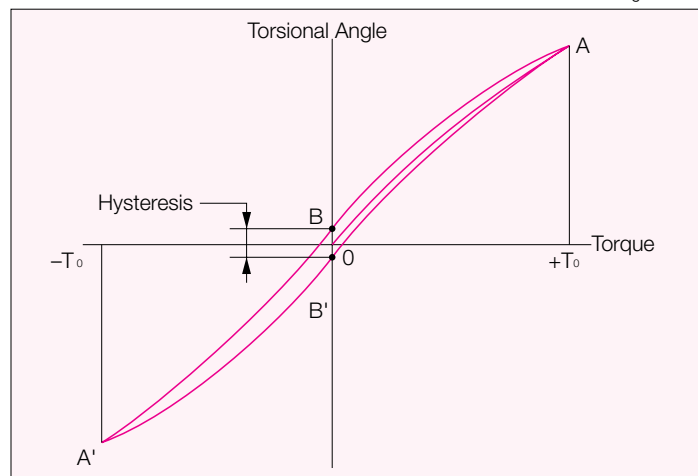
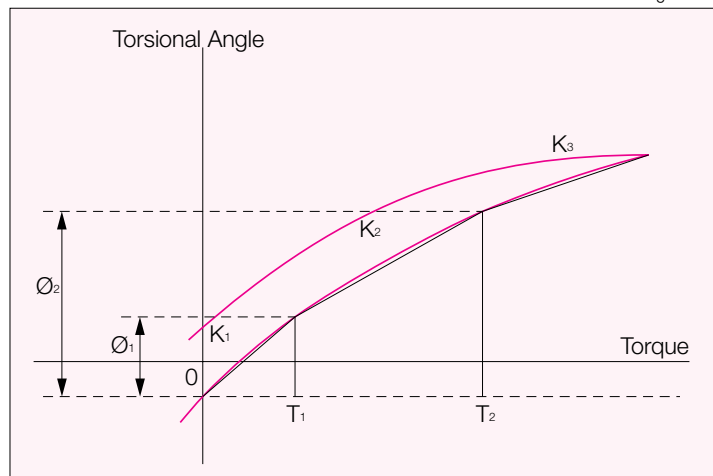

Figure 11



Ratio 1/30

Table 41

Size	8	11	14	17	20	25	32
T_1 Nm	0.29	0.80	2.0	3.9	7.0	14	29
K_1 $\times 10^4$ Nm/rad	0.034	0.084	0.19	0.34	0.57	1.0	2.4
\varnothing_1 $\times 10^{-4}$ rad	8.5	9.5	10.5	11.5	12.3	14	12.1
arc min	3.0	3.3	3.6	4.0	4.1	4.7	4.3
T_2 Nm	0.75	2.0	6.9	12	25	48	108
K_2 $\times 10^4$ Nm/rad	0.044	0.13	0.24	0.44	0.71	1.3	3.0
\varnothing_2 $\times 10^{-4}$ rad	19	19	31	30	38	40	38
arc min	6.6	6.5	10.7	10.2	12.7	13.4	13.3
K_3 $\times 10^4$ Nm/rad	0.054	0.16	0.34	0.67	1.1	2.1	4.9

Torsional Stiffness for Ratio 1/50

Table 42

Size	8	11	14	17	20	25	32	40	45	50	58	65	80	90	100
T_1 Nm	0.29	0.80	2.0	3.9	7.0	14	29	54	76	108	168	235	430	618	843
K_1 $\times 10^4$ Nm/rad	0.044	0.22	0.34	0.81	1.3	2.5	5.4	10	15	20	31	44	81	118	162
\varnothing_1 $\times 10^{-4}$ rad	6.6	3.6	5.8	4.9	5.2	5.5	5.5	5.2	5.2	5.5	5.2	5.2	5.2	5.2	5.2
arc-min	2.3	1.2	2.0	1.7	1.8	1.9	1.9	1.8	1.8	1.9	1.8	1.8	1.8	1.8	1.8
T_2 Nm	0.75	2.0	6.9	12	25	48	108	196	275	382	598	843	1570	2260	3040
K_2 $\times 10^4$ Nm/rad	0.067	0.30	0.47	1.1	1.8	3.4	7.8	14	20	28	44	61	115	162	222
\varnothing_2 $\times 10^{-4}$ rad	13	8	16	12	15.4	15.7	15.7	15.4	15.1	15.4	15.1	15.1	15.1	15.4	15.1
arc-min	4.7	2.6	5.6	4.2	5.3	5.4	5.4	5.3	5.2	5.3	5.2	5.2	5.2	5.3	5.2
K_3 $\times 10^4$ Nm/rad	0.084	0.32	0.57	1.3	2.3	4.4	9.8	18	26	34	54	78	145	206	283

Numbers are average value.

Torsional Stiffness for Ratio 1/80 and up

Table 43

Size	8	11	14	17	20	25	32	40	45	50	58	65	80	90	100
T_1 Nm	0.29	0.80	2.0	3.9	7.0	14	29	54	76	108	168	235	430	618	843
K_1 $\times 10^4$ Nm/rad	0.091	0.27	0.47	1	1.6	3.1	6.7	13	18	25	40	54	100	145	200
\varnothing_1 $\times 10^{-4}$ rad	3.2	3.0	4.1	3.9	4.4	4.4	4.4	4.1	4.1	4.4	4.1	4.4	4.4	4.4	4.4
arc-min	1.1	1.0	1.4	1.3	1.5	1.5	1.5	1.4	1.4	1.5	1.4	1.5	1.5	1.5	1.5
T_2 Nm	0.75	2.0	6.9	12	25	48	108	196	275	382	598	843	1570	2260	3040
K_2 $\times 10^4$ Nm/rad	0.10	0.34	0.61	1.4	2.5	5.0	11	20	29	40	61	88	162	230	310
\varnothing_2 $\times 10^{-4}$ rad	8	6	12	9.7	11.3	11.1	11.6	11.1	11.1	11.1	11.1	11.3	11.3	11.6	11.3
arc-min	2.6	2.2	4.2	3.3	3.9	3.8	4.0	3.8	3.8	3.8	3.8	3.9	3.9	4.0	3.9
K_3 $\times 10^4$ Nm/rad	0.12	0.44	0.71	1.6	2.9	5.7	12	23	33	44	71	98	185	263	370

Numbers are average value.

Calculate Torsion Angle

1. For $T < T_1$: $\Theta = T/K_1$
2. For $T_1 < T < T_2$: $\Theta = T_1/K_1 + (T - T_1)/K_2$
3. For $T_2 < T$: $\Theta = T_1/K_1 + (T_2 - T_1)/K_1 + (T - T_2)/K_3$

Note: Units for T, T_1 , T_2 , K, K_1 , K_2 , K_3 , and Θ must be consistent.

Hysteresis Loss

A typical hysteresis curve is shown in figure 10. With the input locked, a torque is applied from 0 to \pm Rated Torque. Hysteresis measurement is shown in the figure. The following table shows typical hysteresis values.

Size		8	11	14	17	20	25	32	40
30	X10 ⁻⁴ rad	8.7	8.7	8.7	8.7	8.7	8.7	-	-
	arc min	3	3	3	3	3	3	3	-
50	X10 ⁻⁴ rad	8.7	5.8	2.9	2.9	2.9	2.9	2.9	2.9
	arc min	3	2	1	1	1	1	1	1
80	X10 ⁻⁴ rad	5.8	5.8	2.9	2.9	2.9	2.9	2.9	2.9
	arc min	1	1	1	1	1	1	1	1

Backlash from Oldham Coupling

The gear element has zero backlash. However, an Oldham coupling is included as standard with all gearing components and gearheads. The Oldham coupling compensates for motor shaft concentricity errors. Unfortunately, the Oldham coupling does add a small amount of backlash to the system. Backlash values are shown in table 45. This amount of backlash is usually negligible. Component sets and gearheads can be supplied without an Oldham coupling. This is called a "Direct Drive" version.

Size		8	11	14	17	20	25	32	40	45	50	58	65	80	90	100
30	X10 ⁻⁵ rad	28.6	23.8	29.1	16.0	13.6	13.6	11.2	-	-	-	-	-	-	-	-
	arc sec	59	49	60	33	28	28	23	-	-	-	-	-	-	-	-
50	X10 ⁻⁵ rad	17.0	14.1	17.5	9.7	8.2	8.2	6.8	6.8	5.8	5.8	4.8	4.8	4.8	3.9	2.9
	arc sec	35	24	36	20	17	17	14	14	12	12	10	10	10	8	6
80	X10 ⁻⁵ rad	-	-	11.2	6.3	5.3	5.3	4.4	4.4	3.9	3.9	2.9	2.9	2.9	2.4	2.4
	arc sec	-	-	23	13	11	11	9	9	8	8	6	6	6	5	5
100	X10 ⁻⁵ rad	8.7	7.3	8.7	4.8	4.4	4.4	3.4	3.4	2.9	2.9	2.4	2.4	2.4	1.9	1.9
	arc sec	18	15	18	10	9	9	7	7	6	6	5	5	5	4	3
120	X10 ⁻⁵ rad	-	-	-	3.9	3.9	3.9	2.7	2.9	2.4	2.4	1.9	1.9	1.9	1.5	1.5
	arc sec	-	-	-	8	8	8	6	6	5	5	4	4	3	3	3
160	X10 ⁻⁵ rad	-	-	-	-	2.9	2.9	2.4	2.4	1.9	1.9	1.5	1.5	1.5	1.0	1.0
	arc sec	-	-	-	-	6	6	5	5	4	4	3	3	3	2	2

Surface Treatment

Corrosion resistant surface treatments are available for exposed areas of Harmonic Drive™ products. Additionally some components can be manufactured using corrosion resistant steels.

All products are warranted to be free from design or manufacturing defects for a period of one year from the date of shipment. Such items will be repaired or replaced at the discretion of Harmonic Drive LLC. The seller makes no warranty, expressed or implied, concerning the material to be furnished other than it shall be of the quality and specifications stated. The seller's liability for any breach is limited to the purchase price of the product. All efforts have been made to assure that the information in this catalog is complete and accurate. However, Harmonic Drive LLC is not liable for any errors, omissions or inaccuracies in the reported data. Harmonic Drive LLC reserves the right to change the product specifications, for any reason, without prior notice.